

Operating Manual

APT.line™ BD (E2)

Incubators with gravity (natural) convection

APT.line™ ED (E2)

Heating ovens with gravity convection

APT.line™ FD (E2)

Heating ovens with forced convection

with R3 Controller

BINDER GmbH

Address	Post office box 102 D-78502 Tuttlingen
Tel.	+49 7462 2005 0
Fax	+49 7462 2005 100
Internet	http://www.binder-world.com
E-mail	info@binder-world.com
Service Hotline	+49 7462 2005 555
Service Fax	+49 7462 2005 93 555
Service E-Mail	service@binder-world.com
Service Hotline USA	+1 866 885 9794 or +1 631 224 4340
Service Hotline Spain	+34 9492 677 23
Service Hotline Asia Pacific	+852 39070500 or +852 39070503
Service Hotline Russia and CIS	+7 495 98815 17



EG – KONFORMITÄTSERKLÄRUNG
EC - DECLARATION OF CONFORMITY
CE - DECLARATION DE CONFORMITE

Anbieter / Supplier / Fournisseur: BINDER GmbH
Anschrift / Address / Adresse: Im Mittleren Ösch 5, D-78532 Tuttlingen
Produkt / Product / Produit: Brutschränke mit natürlicher Umluft
Incubators with gravity (natural) convection
Incubateurs à circulation d'air naturelle
Typenbezeichnung / Type / Type: BD 23, BD 53, BD 115, BD 240, BD 400, BD 720

Die oben beschriebenen Produkte sind konform mit folgenden EG-Richtlinien:
The products described above are in conformity with the following EC guidelines:
Les produits décrits ci-dessus sont conformes aux directives CE suivantes:

Niederspannungsrichtlinie 2006/95/EG Low voltage directive 2006/95/EC Directive basse tension 2006/95/CE	Richtlinie 2006/95/EG des Europäischen Parlaments und des Rates vom 12. Dezember 2006 zur Angleichung der Rechtsvorschriften der Mitgliedstaaten betreffend elektrische Betriebsmittel zur Verwendung innerhalb bestimmter Spannungsgrenzen Council Directive 2006/95/EC of 12 December 2006 on the harmonization of the laws of Member States relating to electrical equipment designed for use within certain voltage limits Directive 2006/95/CE du Parlement Européen et du Conseil du 12 décembre 2006 concernant le rapprochement des législations des États membres relatives au matériel électrique destiné à être employé dans certaines limites de tension
EMV-Richtlinie 2004/108/EG EMC Directive 2004/108/EC Directive CEM 2004/108/CE	Richtlinie 2004/108/EG des Europäischen Parlaments und des Rates vom 15. Dezember 2004 zur Angleichung der Rechtsvorschriften der Mitgliedstaaten über die elektromagnetische Verträglichkeit und zur Aufhebung der Richtlinie 89/336/EWG. Directive 2004/108/EC of the European Parliament and of the Council of 15 December 2004 on the approximation of the laws of the Member States relating to electromagnetic compatibility and repealing Directive 98/336/EEC. Directive 2004/108/CE du Parlement Européen et du Conseil du 15 décembre 2004 relative au rapprochement des législations des États membres concernant la compatibilité électromagnétique et abrogeant le directive 98/336/CEE.

Die oben beschriebenen Produkte tragen entsprechend die Kennzeichnung CE.
The products described above, corresponding to this, bear the CE-mark.
Les produits décrits ci-dessus, en correspondance, portent l'indication CE.

**Die oben beschriebenen Produkte sind konform mit folgenden harmonisierten Normen:
The products described above are in conformity with the following harmonized standards:
Les produits décrits ci-dessus sont conformes aux normes harmonisées suivantes:**

Sicherheit / safety / sécurité:

- EN 61010-1:2001 Sicherheitsbestimmungen für elektrische Mess-, Steuer-, Regel- und Laborgeräte – Teil 1: Allgemeine Anforderungen
Safety requirements for electrical equipment for measurement, control, and laboratory use – Part 1: General requirements
Règles de sécurité pour appareils électriques de mesure, de régulation et de laboratoire – Partie 1 : Prescriptions générales
- EN 61010-2-010:2003 Sicherheitsbestimmungen für elektrische Meß-, Steuer-, Regel- und Laborgeräte – Teil 2-010: Besondere Anforderungen an Laborgeräte für das Erhitzen von Stoffen
Safety requirements for electrical equipment for measurement, control, and laboratory use – Part 2-010: Particular requirements for laboratory equipment for the heating of materials
Règles de sécurité pour appareils électriques de mesure, de régulation et de laboratoire. Partie 2-010 : Prescriptions particulières pour appareils de laboratoire utilisés pour l'échauffement des matières

EMV / EMC / CEM:

- EN 61326-1:2006 + Corr. 2008 Elektrische Mess-, Steuer-, Regel- und Laborgeräte – EMV-Anforderungen. Teil 1: Allgemeine Anforderungen.
Electrical equipment for measurement, control and laboratory use – EMC requirements. Part 1: General requirements.
Matériel électrique de mesure, de commande et de laboratoire – Exigences relatives à la CEM. Partie 1: Exigences générales.
- EN 61326-2-2:2006 Elektrische Mess-, Steuer-, Regel- und Laborgeräte – EMV-Anforderungen. Teil 2-2: Besondere Anforderungen - Prüfanordnung, Betriebsbedingungen und Leistungsmerkmale für ortsveränderliche Prüf-, Mess- und Überwachungsgeräte in Niederspannungs-Stromversorgungsnetzen.
Electrical equipment for measurement, control and laboratory use – EMC requirements. Part 2-2: Particular requirements - Test configurations, operational conditions and performance criteria for portable test, measuring and monitoring equipment used in low-voltage distribution systems.
Matériel électrique de mesure, de commande et de laboratoire – Exigences relatives à la CEM. Partie 2-2: Exigences particulières - Configurations d'essai, conditions de fonctionnement et critères d'aptitude à la fonction des matériels portatifs d'essai, de mesure et de surveillance utilisés dans des systèmes de distribution basse tension.

D-78532 Tuttlingen, 14.07.2010

BINDER GmbH



P. M. Binder
Geschäftsführender Gesellschafter
Managing Director
Directeur général

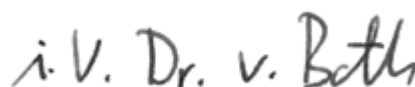

Dr. H. von Both
Leiter F & E
Director R & D
Chef de service R&D



EG – KONFORMITÄTSERKLÄRUNG
EC - DECLARATION OF CONFORMITY
CE - DECLARATION DE CONFORMITE

Anbieter / Supplier / Fournisseur: BINDER GmbH
Anschrift / Address / Adresse: Im Mittleren Ösch 5, D-78532 Tuttlingen
Produkt / Product / Produit: Wärme-/Trockenschränke mit natürlicher Umluft
Heating ovens with gravity convection
Etuves universelles à circulation d'air naturelle
Typenbezeichnung / Type / Type: ED 23, ED 53, ED 115, ED 240, ED 400, ED 720

Die oben beschriebenen Produkte sind konform mit folgenden EG-Richtlinien:
The products described above are in conformity with the following EC guidelines:
Les produits décrits ci-dessus sont conformes aux directives CE suivantes:

Niederspannungsrichtlinie 2006/95/EG	Richtlinie 2006/95/EG des Europäischen Parlaments und des Rates vom 12. Dezember 2006 zur Angleichung der Rechtsvorschriften der Mitgliedstaaten betreffend elektrische Betriebsmittel zur Verwendung innerhalb bestimmter Spannungsgrenzen
Low voltage directive 2006/95/EC	
Directive basse tension 2006/95/CE	Council Directive 2006/95/EC of 12 December 2006 on the harmonization of the laws of Member States relating to electrical equipment designed for use within certain voltage limits
	Directive 2006/95/CE du Parlement Européen et du Conseil du 12 décembre 2006 concernant le rapprochement des législations des États membres relatives au matériel électrique destiné à être employé dans certaines limites de tension
EMV-Richtlinie 2004/108/EG	Richtlinie 2004/108/EG des Europäischen Parlaments und des Rates vom 15. Dezember 2004 zur Angleichung der Rechtsvorschriften der Mitgliedstaaten über die elektromagnetische Verträglichkeit und zur Aufhebung der Richtlinie 89/336/EWG.
EMC Directive 2004/108/EC	
Directive CEM 2004/108/CE	Directive 2004/108/EC of the European Parliament and of the Council of 15 December 2004 on the approximation of the laws of the Member States relating to electromagnetic compatibility and repealing Directive 98/336/EEC.
	Directive 2004/108/CE du Parlement Européen et du Conseil du 15 décembre 2004 relative au rapprochement des législations des États membres concernant la compatibilité électromagnétique et abrogeant le directive 98/336/CEE.

Die oben beschriebenen Produkte tragen entsprechend die Kennzeichnung CE.
The products described above, corresponding to this, bear the CE-mark.
Les produits décrits ci-dessus, en correspondance, portent l'indication CE.

**Die oben beschriebenen Produkte sind konform mit folgenden harmonisierten Normen:
The products described above are in conformity with the following harmonized standards:
Les produits décrits ci-dessus sont conformes aux normes harmonisées suivantes:**

Sicherheit / safety / sécurité:

- EN 61010-1:2001 Sicherheitsbestimmungen für elektrische Mess-, Steuer-, Regel- und Laborgeräte – Teil 1: Allgemeine Anforderungen
Safety requirements for electrical equipment for measurement, control, and laboratory use – Part 1: General requirements
Règles de sécurité pour appareils électriques de mesure, de régulation et de laboratoire – Partie 1 : Prescriptions générales
- EN 61010-2-010:2003 Sicherheitsbestimmungen für elektrische Meß-, Steuer-, Regel- und Laborgeräte – Teil 2-010: Besondere Anforderungen an Laborgeräte für das Erhitzen von Stoffen
Safety requirements for electrical equipment for measurement, control, and laboratory use – Part 2-010: Particular requirements for laboratory equipment for the heating of materials
Règles de sécurité pour appareils électriques de mesure, de régulation et de laboratoire. Partie 2-010 : Prescriptions particulières pour appareils de laboratoire utilisés pour l'échauffement des matières

EMV / EMC / CEM:

- EN 61326-1:2006 + Corr. 2008 Elektrische Mess-, Steuer-, Regel- und Laborgeräte – EMV-Anforderungen. Teil 1: Allgemeine Anforderungen.
Electrical equipment for measurement, control and laboratory use – EMC requirements. Part 1: General requirements.
Matériel électrique de mesure, de commande et de laboratoire – Exigences relatives à la CEM. Partie 1: Exigences générales.
- EN 61326-2-2:2006 Elektrische Mess-, Steuer-, Regel- und Laborgeräte – EMV-Anforderungen. Teil 2-2: Besondere Anforderungen - Prüfanordnung, Betriebsbedingungen und Leistungsmerkmale für ortsveränderliche Prüf-, Mess- und Überwachungsgeräte in Niederspannungs-Stromversorgungsnetzen.
Electrical equipment for measurement, control and laboratory use – EMC requirements. Part 2-2: Particular requirements - Test configurations, operational conditions and performance criteria for portable test, measuring and monitoring equipment used in low-voltage distribution systems.
Matériel électrique de mesure, de commande et de laboratoire – Exigences relatives à la CEM. Partie 2-2: Exigences particulières - Configurations d'essai, conditions de fonctionnement et critères d'aptitude à la fonction des matériels portatifs d'essai, de mesure et de surveillance utilisés dans des systèmes de distribution basse tension.

D-78532 Tuttlingen, 14.07.2010

BINDER GmbH



P. M. Binder
Geschäftsführender Gesellschafter
Managing Director
Directeur général

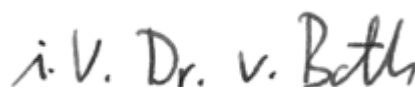

Dr. H. von Both
Leiter F & E
Director R & D
Chef de service R&D



EG – KONFORMITÄTSERKLÄRUNG
EC - DECLARATION OF CONFORMITY
CE - DECLARATION DE CONFORMITE

Anbieter / Supplier / Fournisseur: BINDER GmbH
Anschrift / Address / Adresse: Im Mittleren Ösch 5, D-78532 Tuttlingen
Produkt / Product / Produit: Wärme-/Trockenschränke mit forcierter Umluft
Heating ovens with forced convection
Etuves universelles à circulation d'air forcée
Typenbezeichnung / Type / Type: FD 23, FD 53, FD 115, FD 240

Die oben beschriebenen Produkte sind konform mit folgenden EG-Richtlinien:
The products described above are in conformity with the following EC guidelines:
Les produits décrits ci-dessus sont conformes aux directives CE suivantes:

Niederspannungsrichtlinie 2006/95/EG Low voltage directive 2006/95/EC Directive basse tension 2006/95/CE	Richtlinie 2006/95/EG des Europäischen Parlaments und des Rates vom 12. Dezember 2006 zur Angleichung der Rechtsvorschriften der Mitgliedstaaten betreffend elektrische Betriebsmittel zur Verwendung innerhalb bestimmter Spannungsgrenzen Council Directive 2006/95/EC of 12 December 2006 on the harmonization of the laws of Member States relating to electrical equipment designed for use within certain voltage limits Directive 2006/95/CE du Parlement Européen et du Conseil du 12 décembre 2006 concernant le rapprochement des législations des États membres relatives au matériel électrique destiné à être employé dans certaines limites de tension
EMV-Richtlinie 2004/108/EG EMC Directive 2004/108/EC Directive CEM 2004/108/CE	Richtlinie 2004/108/EG des Europäischen Parlaments und des Rates vom 15. Dezember 2004 zur Angleichung der Rechtsvorschriften der Mitgliedstaaten über die elektromagnetische Verträglichkeit und zur Aufhebung der Richtlinie 89/336/EWG. Directive 2004/108/EC of the European Parliament and of the Council of 15 December 2004 on the approximation of the laws of the Member States relating to electromagnetic compatibility and repealing Directive 98/336/EEC. Directive 2004/108/CE du Parlement Européen et du Conseil du 15 décembre 2004 relative au rapprochement des législations des États membres concernant la compatibilité électromagnétique et abrogeant le directive 98/336/CEE.

Die oben beschriebenen Produkte tragen entsprechend die Kennzeichnung CE.
The products described above, corresponding to this, bear the CE-mark.
Les produits décrits ci-dessus, en correspondance, portent l'indication CE.

**Die oben beschriebenen Produkte sind konform mit folgenden harmonisierten Normen:
The products described above are in conformity with the following harmonized standards:
Les produits décrits ci-dessus sont conformes aux normes harmonisées suivantes:**

Sicherheit / safety / sécurité:

- EN 61010-1:2001 Sicherheitsbestimmungen für elektrische Mess-, Steuer-, Regel- und Laborgeräte – Teil 1: Allgemeine Anforderungen
Safety requirements for electrical equipment for measurement, control, and laboratory use – Part 1: General requirements
Règles de sécurité pour appareils électriques de mesure, de régulation et de laboratoire – Partie 1 : Prescriptions générales
- EN 61010-2-010:2003 Sicherheitsbestimmungen für elektrische Meß-, Steuer-, Regel- und Laborgeräte – Teil 2-010: Besondere Anforderungen an Laborgeräte für das Erhitzen von Stoffen
Safety requirements for electrical equipment for measurement, control, and laboratory use – Part 2-010: Particular requirements for laboratory equipment for the heating of materials
Règles de sécurité pour appareils électriques de mesure, de régulation et de laboratoire. Partie 2-010 : Prescriptions particulières pour appareils de laboratoire utilisés pour l'échauffement des matières

EMV / EMC / CEM:

- EN 61326-1:2006 + Corr. 2008 Elektrische Mess-, Steuer-, Regel- und Laborgeräte – EMV-Anforderungen. Teil 1: Allgemeine Anforderungen.
Electrical equipment for measurement, control and laboratory use – EMC requirements. Part 1: General requirements.
Matériel électrique de mesure, de commande et de laboratoire – Exigences relatives à la CEM. Partie 1: Exigences générales.
- EN 61326-2-2:2006 Elektrische Mess-, Steuer-, Regel- und Laborgeräte – EMV-Anforderungen. Teil 2-2: Besondere Anforderungen - Prüfanordnung, Betriebsbedingungen und Leistungsmerkmale für ortsveränderliche Prüf-, Mess- und Überwachungsgeräte in Niederspannungs-Stromversorgungsnetzen.
Electrical equipment for measurement, control and laboratory use – EMC requirements. Part 2-2: Particular requirements - Test configurations, operational conditions and performance criteria for portable test, measuring and monitoring equipment used in low-voltage distribution systems.
Matériel électrique de mesure, de commande et de laboratoire – Exigences relatives à la CEM. Partie 2-2: Exigences particulières - Configurations d'essai, conditions de fonctionnement et critères d'aptitude à la fonction des matériels portatifs d'essai, de mesure et de surveillance utilisés dans des systèmes de distribution basse tension.

D-78532 Tuttlingen, 14.07.2010

BINDER GmbH



P. M. Binder
Geschäftsführender Gesellschafter
Managing Director
Directeur général

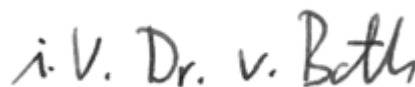

Dr. H. von Both
Leiter F & E
Director R & D
Chef de service R&D

Content

1. SAFETY	10
1.1 Legal considerations	10
1.2 Structure of the safety instructions.....	10
1.2.1 Signal word panel	10
1.2.2 Safety alert symbol	11
1.2.3 Pictograms	11
1.2.4 Word message panel structure.....	12
1.3 Localization / position of safety labels on the unit.....	12
1.4 Type plate	13
1.5 General safety instructions on installing and operating the incubators BD and heating ovens ED and FD	14
1.6 Intended use	15
1.6.1 Incubators BD	15
1.6.2 Heating ovens ED and FD	15
2. UNIT DESCRIPTION	16
2.1 Equipment overview BD/ED/FD.....	16
3. COMPLETENESS OF DELIVERY, TRANSPORTATION, STORAGE, AND INSTALLATION	17
3.1 Unpacking, and checking equipment and completeness of delivery.....	17
3.2 Guidelines for safe lifting and transportation	17
3.3 Storage.....	18
3.4 Location of installation and ambient conditions	18
4. INSTALLATION OF THE EQUIPMENT	19
4.1 Electrical connection	19
4.2 Connection to a suction plant (optional)	20
5. START UP	21
5.1 Turning on the unit	21
5.2 Heating operation display	21
5.3 Air change	21
6. CONTROLLER SETTING	22
6.1 Display / entry of temperature set-point (without ramp function).....	22
6.2 Display / entry of temperature set-point (with selected temperature ramp).....	22
6.3 Time functions: Continuous operation and Timer operation.....	23
6.3.1 Switching between Continuous operation and Timer operation.....	24
6.3.2 Continuous operation.....	24
6.3.3 Timer operation: Setting the tempering time.....	25
6.4 User level settings.....	26
6.4.1 Temperature unit change between degrees Celsius °C and degrees Fahrenheit °F.....	26
6.4.2 Enter a temperature ramp.....	27
6.4.3 Chamber addressing.....	27
6.5 General notes.....	28
7. SAFETY DEVICES	29
7.1 Temperature safety device class 2 (DIN 12880) ED, FD	29
7.2 Temperature safety device class 3.1 (DIN 12880) BD (option ED, FD).....	30
8. OPTIONS	31
8.1 Disconnectable audible over-temperature alarm (option).....	31
8.2 Communication software APT-COM™ 3 DataControlSystem (BD, option ED)	32



8.3	Analog output for temperature (option).....	32
8.4	Additional Pt100 temperature sensor (option BD).....	32
8.5	Water protected internal socket (option BD).....	33
9.	MAINTENANCE, CLEANING, AND SERVICE	33
9.1	Maintenance intervals, service.....	33
9.2	Cleaning and decontamination	34
9.3	Sending the unit back to BINDER GmbH	35
10.	DISPOSAL.....	36
10.1	Disposal of the transport packing	36
10.2	Decommissioning.....	36
10.3	Disposal of the unit in the Federal Republic of Germany	36
10.4	Disposal of the unit in the member states of the EC except for the Federal Republic of Germany	38
10.5	Disposal of the unit in non-member states of the EC	39
11.	TROUBLESHOOTING	39
12.	TECHNICAL DESCRIPTION.....	40
12.1	Factory calibration and adjustment.....	40
12.2	Definition of usable volume	40
12.3	Over current protection	41
12.4	BD technical data	41
12.5	ED technical data	43
12.6	FD technical data	44
12.7	Equipment and Options Series BD	46
12.8	Equipment and Options Series ED	47
12.9	Equipment and Options Series FD	48
12.10	Spare parts.....	49
13.	CONTAMINATION CLEARANCE CERTIFICATE	52

Dear customer,

For the correct operation of the incubators BD and heating ovens ED and FD, it is important that you read this operating manual completely and carefully and observe all instructions as indicated. Failure to read, understand and follow the instructions may result in personal injury. It can also lead to damage to the unit and/or poor equipment performance.

1. Safety

This operating manual is part of the components of delivery. Always keep it handy for reference. The device should only be operated by laboratory personnel especially trained for this purpose and familiar with all precautionary measures required for working in a laboratory. To avoid injuries and damage observe the safety instructions of the operating manual.

	 WARNING
	<p>Failure to observe the safety instructions. Serious injuries and unit damage.</p> <ul style="list-style-type: none"> ➤ Observe the safety instructions in this operating manual ➤ Carefully read the complete operating instructions of the incubators BD and heating ovens ED and FD

1.1 Legal considerations

This operating manual is for informational purposes only. It contains information for installing, start-up, operation and maintenance of the product. Note: the contents and the product described are subject to change without notice.

Understanding and observing the instructions in this operating manual are prerequisites for hazard-free use and safety during operation and maintenance. In no event shall BINDER be held liable for any damages, direct or incidental arising out of or related to the use of this manual.

This operating manual cannot cover all conceivable applications. If you would like additional information, or if special problems arise that are not sufficiently addressed in this manual, please ask your dealer or contact us directly by phone at the number located on page one of this manual

Furthermore, we emphasize that the contents of this operating manual are not part of an earlier or existing agreement, description, or legal relationship, nor do they modify such a relationship. All obligations on the part of BINDER derive from the respective purchase contract, which also contains the entire and exclusively valid statement of warranty administration. The statements in this manual neither augment nor restrict the contractual warranty provisions.

1.2 Structure of the safety instructions

In this operating manual, the following safety definitions and symbols indicate dangerous situations following the harmonization of ISO 3864-2 and ANSI Z535.6.

1.2.1 Signal word panel

Depending on the probability of serious consequences, potential dangers are identified with a signal word, the corresponding safety color, and if appropriate, the safety alert symbol.

 DANGER
<p>Indicates an imminently hazardous situation that, if not avoided, will result in death or serious (irreversible) injury.</p>

WARNING

Indicates a potentially hazardous situation which, if not avoided, could result in death or serious (irreversible) injury

CAUTION

Indicates a potentially hazardous situation which, if not avoided, may result in moderate or minor (reversible) injury

CAUTION

Indicates a potentially hazardous situation which, if not avoided, may result in damage to the product and/or its functions or of a property in its proximity.

1.2.2 Safety alert symbol



Use of the safety alert symbol indicates a **risk of injury**.

Observe all measures that are marked with the safety alert symbol in order to avoid death or injury.

1.2.3 Pictograms

Warning signs			
Electrical hazard	Hot surface	Explosive atmosphere	Stability hazard
Pollution Hazard	Harmful substances	Biohazard	Lifting hazard
Mandatory action signs			
Mandatory regulation	Read operating instructions	Disconnect the power plug	Lift with several persons
Lift with mechanical assistance	Environment protection		
Prohibition signs			
Do NOT touch	Do NOT spray with water		



Information to be observed in order to ensure optimum function of the product.

1.2.4 Word message panel structure

Type / cause of hazard.



Possible consequences.

- ⊘ Instruction how to avoid the hazard: prohibition.
- Instruction how to avoid the hazard: mandatory action.

Observe all other notes and information not necessarily emphasized in the same way, in order to avoid disruptions that could result in direct or indirect injury or property damage.

1.3 Localization / position of safety labels on the unit

The following labels are located on the unit:

Pictograms (Warning signs)	Service label
 <p>Hot surface</p>	

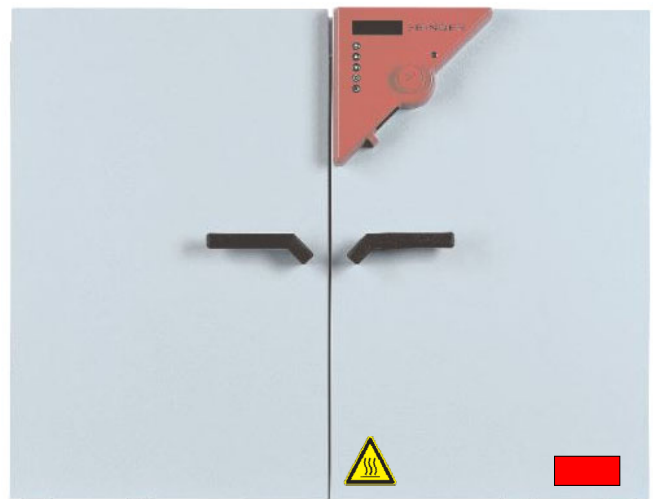
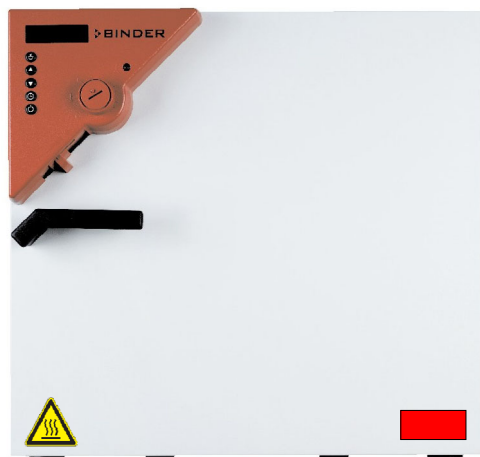

Figure 1: Position of labels on the unit



Keep safety labels complete and legible.

Replace safety labels that are no longer legible. Contact BINDER Service for these replacements.

1.4 Type plate

The type plate is located on the left-hand side of the unit (size 23) or on the unit front behind the door, bottom left-hand.





Nominal temperature	300 °C 572°F	1,60 kW 230 V 1 N ~	
Enclosure protection	IP 20	7,0 A	
Temp. safety device	DIN 12880	50/60 Hz	
Class	2.0		
Art. No.	9020-0102	US PATS 5405194 / 5222612	
Project No.		US PATS 4585923 / 5309981	

BINDER D 78532 Tuttlingen / Germany
Tel. + 49 (0) 7462/ 2005-0
Internet: www.binder-world.com

FD 115 Serial No. 00-00000
Made in Germany

Figure 2: Type plate (example: FD 115 regular unit)

Indications of the type plate		Information
Nominal temperature	300 °C 572°F	Nominal temperature
Enclosure protection	IP 20	IP type of protection 20 acc. to EN 60529
Temp. safety device	DIN 12880	Temperature safety device acc. to standard DIN 12880
Class	2.0	Temperature safety device, class 2
Art. No.	9010-0102	Art. No. 9010-0102
Project No.	---	(Special application acc. to project no.)
1,60 kW		Nominal power 1.60 kW
230 V 1 N ~		Nominal voltage 230 V ± 10%, single-phase unit
7,0 A		Nominal current 7.0 Amp
50/60 Hz		Power frequency 50/60 Hz
FD 115		Model FD 115
Serial No. 00-00000		Serial No. 00-00000

Symbol on the type plate	Information
	CE conformity marking
	Electrical and electronic equipment manufactured / placed on the market in the EC after 13 August 2005 and to be disposed of in a separate collection according to directive 2002/96/EC on waste electrical and electronic equipment (WEEE).
	VDE-GS certification mark
	The equipment is certified in the GOST R certification system of GOSTSTANDARD Russia.
 (UL units only)	The equipment is certified by Underwriters Laboratories Inc.® according to standards UL 61010A-1, UL 61010A-2-10, CSA C22.2 No. 1010.1-92, and CSA C22.2 No. 1010.2.010-94.

1.5 General safety instructions on installing and operating the incubators BD and heating ovens ED and FD



With regard to operating the incubators BD and heating ovens ED and FD and to the installation location, please observe regulations BGR 120 issued by the German professional association for the chemical industry (formerly ZH 1/119 laboratory guidelines issued by the employers' liability insurance association) (for Germany).

BINDER GmbH is only responsible for the safety features of the unit provided skilled electricians or qualified personnel authorized by BINDER perform all maintenance and repair, and if components relating to chamber safety are replaced in the event of failure with original spare parts.



To operate the unit, use only original BINDER accessories or accessories from third-party suppliers authorized by BINDER. The user is responsible for any risk caused by using unauthorized accessories.

	CAUTION
	<p>Danger of overheating. Damage to the unit.</p> <ul style="list-style-type: none"> ⊘ Do NOT install the unit in unventilated recesses. ➤ Ensure sufficient ventilation for dispersal of the heat.

The incubators BD and heating ovens ED and FD must NOT be operated in hazardous locations.



	 DANGER
	<p>Explosion hazard. Danger of death.</p> <ul style="list-style-type: none"> ⊘ Do NOT operate the unit in potentially explosive areas. ➤ KEEP explosive dust or air-solvent mixtures AWAY from the unit.

The incubators BD and heating ovens ED and FD do not dispose of any measures of explosion protection.



	 DANGER
	<p>Explosion hazard. Danger of death.</p> <ul style="list-style-type: none"> ⊘ Do NOT introduce any combustible or explosive substance at working temperature into the heating oven. ⊘ NO explosive dust or air-solvent mixture in the inner chamber.

Any solvent contained in the charging material must not be explosive or inflammable. I.e., irrespective of the solvent concentration in the steam room, NO explosive mixture with air must form. The temperature inside the chamber must lie below the flash point or below the sublimation point of the charging material. Familiarize yourself with the physical and chemical properties of the charging material, as well as the contained moisture constituent and its behavior with the addition of heat energy.

Familiarize yourself with any potential health risks caused by the charging material, the contained moisture constituent or by reaction products that may arise during the temperature process. Take adequate measures to exclude such risks prior to putting the unit into operation.

	 DANGER
	<p>Electrical hazard.</p> <p>Danger of death.</p> <p>∅ The unit must NOT become wet during operation or maintenance.</p>

The incubators BD and heating ovens ED and FD have been produced in accordance with VDE regulations and were routinely tested in accordance to VDE 0411-1 (IEC 61010-1).

	 CAUTION
	<p>The inner chamber, the outgoing air pipe, the door window (option), and the door gaskets will become hot during operation.</p> <p>Danger of burning.</p> <p>∅ Do NOT touch the inner surfaces, the door window, the access ports, the door gaskets or the charging material during operation.</p>

1.6 Intended use

1.6.1 Incubators BD

The incubators BD are designed for exact temperation of harmless materials. Because of their precise temperature accuracy these devices are especially useful for incubation of cultures at a standard temperature of 37 °C / 98.6 °F. Any solvent content must not be explosive or flammable. A mixture of any component of the charging material with air must NOT be explosive. The operating temperature must lie below the flash point or below the sublimation point of the charging material.

Other applications are not approved.

Do NOT use the unit for drying purpose, especially if greater quantities of steam leading to condensation will be set free.

	Observing the instructions in this operating manual and conducting regular maintenance work (chap. 9) is part of the intended use.
---	--

1.6.2 Heating ovens ED and FD

The heating ovens ED and FD are suitable for drying and heat treatment of solid or pulverized charging material, as well as bulk material, using the supply of heat. The solvent content must not be explosive or flammable. A mixture of any component of the charging material with air must NOT be explosive. The operating temperature must lie below the flash point or below the sublimation point of the charging material.

Other applications are not approved.

Do NOT use the unit for drying purpose, especially if greater quantities of steam leading to condensation will be set free.

Due to the special demands of the Medical Device Directive (MDD) this ovens are not qualified for sterilization of medical devices as defined by the directive 93/42/EWG.

	Observing the instructions in this operating manual and conducting regular maintenance work (chap. 9) is part of the intended use.
---	--

2. Unit description

BINDER incubators BD and heating ovens ED and FD are equipped with an electronic PID-controller with digital display.



The incubators BD indicate the temperature with an accuracy of a tenth of a degree.

The heating ovens ED and FD indicate the temperature with an accuracy of one degree.

The incubators BD and the heating ovens ED are heated electrically and are ventilated naturally. Heating ovens FD are ventilated by fan-assisted, forced-air circulation.

BINDER incubators BD and heating ovens ED and FD are regularly equipped with a temperature safety device according to DIN12880 (chap. 7).

The inner chamber, the pre-heating chamber and the inside of the doors are all made of stainless steel (material no. 1.4301 in Germany). When operating the heating ovens ED and FD at temperatures above 150 °C / 302 °F, the impact of the oxygen in the air may cause discoloration of the metallic surfaces (yellowish-brown or blue) by natural oxidation processes. These colorations are harmless and will in no way impair the function or quality of the unit. The housing is RAL 7035 powder-coated. All corners and edges are also completely coated.

BINDER incubators BD and heating ovens ED (option) are equipped with a serial interface RS 422 for computer communication, e.g. via the communication software APT-COM™ 3 DataControlSystem (option, chap. 8.2). For further options, see chap. 12.7 to 12.9.

The models size 720 are equipped with four castors. Both front castors can be locked by brakes.

- Temperature range:
- Incubators BD: 5 °C / 9 °F above room temperature up to 100 °C / 212 °F.
 - Heating ovens ED and FD: 5 °C / 9 °F above room temperature up to 300 °C / 572 °F.



If you want to frequently operate heating ovens ED and FD at low set-points up to 70 °C / 158 °F, the controller parameters can be optimized accordingly. Please contact BINDER Service to obtain detailed instructions how to change the parameters.

2.1 Equipment overview BD/ED/FD

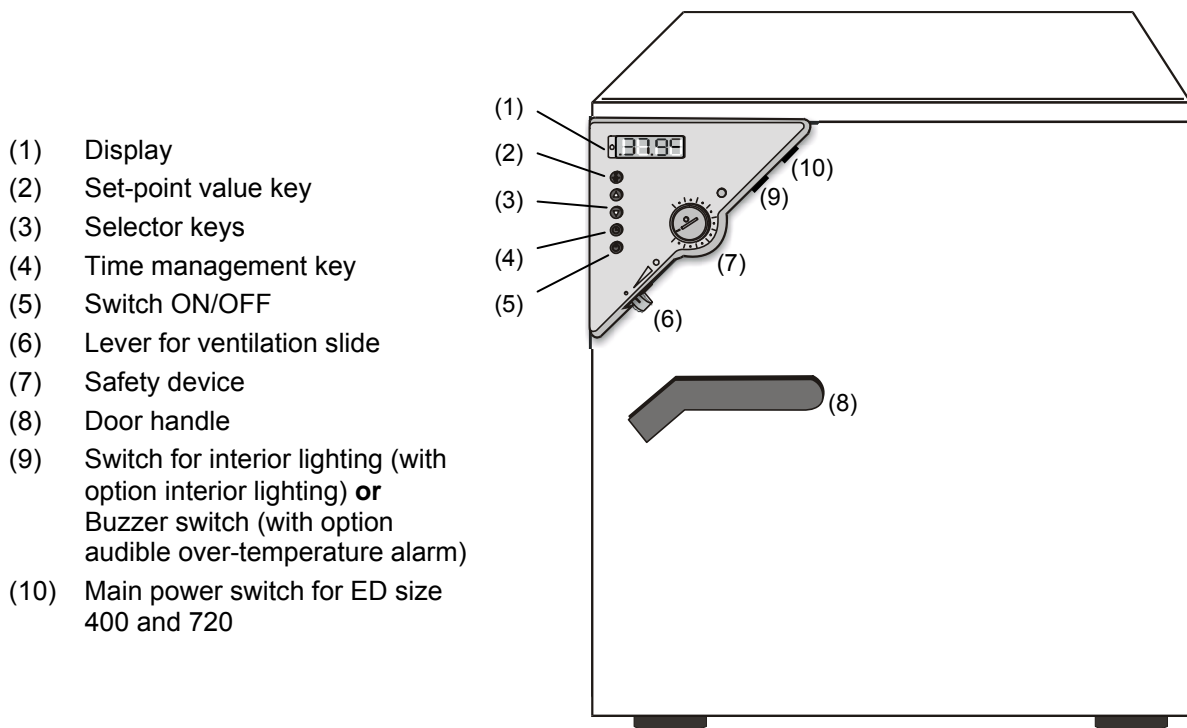

Figure 3: Incubator BD with R3 controller





3. Completeness of delivery, transportation, storage, and installation

3.1 Unpacking, and checking equipment and completeness of delivery

After unpacking, please check the unit and its optional accessories, if any, based on the delivery receipt for completeness and for transportation damage. Inform the carrier immediately if transportation damage has occurred.

The final tests of the manufacturer may have caused traces of the racks on the inner surfaces. This has no impact on the function and performance of the unit.

Please remove any transportation protection devices and adhesives in/on the unit and on the doors and take out the operating manuals and accessory equipment.

   	 CAUTION
<p>Sliding or tilting of the unit.</p> <p>Damage to the unit.</p> <p>Risk of injury by lifting heavy loads.</p> <ul style="list-style-type: none"> Ø Do NOT lift or transport the unit using the door handle or the door. Ø Do NOT lift units size 400 and 720 by hand ➤ Lift the unit size 23, 53, 115 from the pallet at its four lower corners with the aid of 2 people, unit size 240 with the aid of 4 people. ➤ Lift units size 400 and 720 from the pallet using technical devices (fork lifter). Set the fork lifter only from the rear in the middle of the unit. Make sure to place all the lateral supports of the unit on the forks. 	

If you need to return the unit, please use the original packing and observe the guidelines for safe lifting and transportation (chap. 3.2).

For disposal of the transport packing, see chap. 10.1.





Note on second-hand units (Ex-Demo-Units):

Second-hand units are units that have been used for a short time for tests or exhibitions. They are thoroughly tested before resale. BINDER ensures that the chamber is technically sound and will work flawlessly.

Second-hand units are marked with a sticker on the unit door. Please remove the sticker before commissioning the unit.

3.2 Guidelines for safe lifting and transportation

The front castors of units size 720 can be blocked by brakes. Please move the units with castors only when empty and on an even surface, otherwise the castors may be damaged. After operation please observe the guidelines for temporarily decommissioning the unit (chap. 10.2).

	 CAUTION
	<p>Sliding or tilting of the unit.</p> <p>Damage to the unit.</p> <p>Risk of injury by lifting heavy loads.</p> <ul style="list-style-type: none"> ➤ Transport the unit only in its original packaging. ➤ Secure the unit with transport straps for transport. ⊘ Do NOT lift or transport the unit using the door handle or the door. ⊘ Do NOT lift units size 400 and 720 by hand. ➤ Lift unit size 23, 53, 115 at its four lower corners with the aid of 2 people, unit size 240 with the aid of 4 people, and place it on a transport pallet with wheels. Push the pallet to the desired site and then lift the unit from the pallet at its four lower corners. ➤ Place units size 400 and 720 using technical devices (fork lifter) on the transport pallet. Set the fork lifter only from the rear in the middle of the unit. Make sure to place all the lateral supports of the unit on the forks. ➤ Transport units size 400 and 720 ONLY with the original transport pallet. Set the fork lifter only to the pallet. Without the pallet the unit is in imminent danger of overturning!!
	
	

- Permissible ambient temperature range during transport: -10 °C to +60 °C / 14 °F to 140 °F.

You can order transport packing and pallets for transportation purposes from BINDER Service.

3.3 Storage

Intermediate storage of the unit is possible in a closed and dry room. Observe the guidelines for temporary decommissioning (chap. 10.2).

- Permissible ambient temperature range during storage: -10 °C to +60 °C / 14 °F to 140 °F.
- Permissible ambient humidity: max. 70 % r.H., non-condensing

When after storage in a cold location you transfer the unit to its warmer installation site, condensation may form. Before start-up, wait at least one hour until the unit has attained ambient temperature and is completely dry.

3.4 Location of installation and ambient conditions

Set up the incubators BD or the heating oven ED / FD on an even and non-flammable surface, free from vibration and in a well-ventilated, dry location and align it using a spirit level. The site of installation must be capable of supporting the unit's weight (see technical data, chap. 12.4 to 12.6). The chambers are designed for setting up inside a building (indoor use).

	CAUTION
	<p>Danger of overheating.</p> <p>Damage to the unit.</p> <ul style="list-style-type: none"> ⊘ Do NOT set up units in non-ventilated recesses. ➤ Ensure sufficient ventilation for dispersal of the heat.

- Permissible ambient temperature range during operation: +18 °C up to +40 °C / 64.4 °F to 104 °F.

- . At elevated ambient temperature values, fluctuations in temperature can occur.



The ambient temperature should not be substantially higher than the indicated ambient temperature of +25 °C / 77 °F to which the specified technical data relate. For other ambient conditions, deviations from the indicated data are possible.

- Permissible ambient humidity: 70 % r.H. max., non-condensing.
- Installation height: max. 2000 m above sea level.



When placing several units of the same size side by side, maintain a minimum distance of 250 mm between each unit. Wall distances: rear 100 mm, sides 160 mm. Spacing above the unit of at least 100 mm must also be accounted for.

Two devices up to size 115l can be piled on top of each other. For this purpose place rubber pads under all four feet of the upper unit to prevent the device from slipping.

	CAUTION
	<p>Sliding or tilting of the upper unit. Damage to the units.</p> <p>➤ When stacking, place rubber pads under all four feet of the upper unit.</p>

To completely separate the unit from the power supply, you must disconnect the power plug. Install the unit in a way that the power plug is easily accessible and can be easily pulled in case of danger.

Do not install or operate the unit in potentially explosive areas.

	 DANGER
	<p>Explosion hazard. Danger of death.</p> <p>⊘ Do NOT operate the unit in potentially explosive areas. ➤ KEEP explosive dust or air-solvent mixtures AWAY from the vicinity of the unit.</p>

4. Installation of the equipment

4.1 Electrical connection

- **BD all volumes, ED up to volume 240, FD all volumes:**
 Shockproof plug, power supply voltage 230 V (1N~) +/- 10 %, 50/60 Hz
 Fixed power connection cable of 1800 mm in length
- **ED 400, ED 720:**
 CEE plug 5 poles, power supply voltage 400 V (3N~) +/- 10 %, 50/60 Hz
 Fixed power connection cable of 2700 mm in length
- **BD-UL 23, BD-UL 53, BD-UL 115, BD-UL 240, BD-UL 400, ED 23-UL, FD 23-UL:**
 NEMA plug 5-15P, power supply voltage 115 V (1N~) +/- 10 %, 60 Hz
 Fixed power connection cable of 1800 mm in length
- **BD 720-UL, ED 53-UL, ED 115-UL, FD 53-UL, FD 115-UL:**
 NEMA plug 5-20P, power supply voltage 115 V (1N~) +/- 10 %, 60 Hz
 Fixed power connection cable of 1800 mm in length
- **ED 240-UL, ED 400-UL, ED 720-UL, FD 240-UL:**
 NEMA plug L21-20P, power supply voltage 208 V (3N~) +/- 10 %, 60 Hz
 Fixed power connection cable of 2700 mm in length

- Prior to connection and start-up, check the power supply voltage. Compare the values to the specified data located on the unit's type plate (unit front behind the door bottom left-hand, or on the left-hand side of the unit, chap. 1.4).
- When connecting, please observe the regulations specified by the local electricity supply company and as well as the VDE directives (for Germany)
- Pollution degree (acc. to IEC 61010-1): 2
- Over-voltage category (acc. to IEC 61010-1): II

	CAUTION
	<p>Danger of incorrect power supply voltage. Damage to the equipment.</p> <ul style="list-style-type: none"> ➤ Check the power supply voltage before connection and start-up. ➤ Compare the power supply voltage with the data indicated on the type plate.



See also electrical data (chap. 12.4 to 12.6).

	<p>To completely separate the unit from the power supply, you must disconnect the power plug. Install the unit in a way that the power plug is easily accessible and can be easily pulled in case of danger.</p>
---	--

4.2 Connection to a suction plant (optional)

When directly connecting a suction plant the spatial temperature exactitude, the heating-up and the recovering times and the maximum temperature will be negatively influenced. So no suction plant should be directly connected to the outgoing air pipe.

	<p>Active suction from the oven must only be effected together with extraneous air. Perforate the connecting piece to the suction device or place an exhaust funnel at some distance to the outgoing air pipe.</p>
---	--

	 CAUTION
	<p>The exhaust duct will become hot during operation. Danger of burning.</p> <ul style="list-style-type: none"> ∅ Do NOT touch the exhaust duct during operation.

5. Start up

5.1 Turning on the unit



Warming chambers may release odors in the first few days after commissioning. This is not a quality defect. To reduce odors quickly we recommend heating up the chamber to its nominal temperature for one day and in a well ventilated location.

1. Insert plug into socket (chap. 4.1).
2. Turn on ED units of sizes 400 and 720 at the main power switch (10)

The green "Standby" LED illuminates



3. Press  until the display lights up.

The controller is now in normal display (actual value display).

If the oven is operating (time functions "Continuous operation", or "Timer operation" with the set time just running down chap. 6.3), the **actual temperature value** (example: 22 °C) is displayed



If the oven is in time function "Timer operation" with no time programmed or the set time run-off (chap. 6.3), the unit is inactive (no heating). The display alternately shows the **actual temperature value** (example: 22 °C) and "tOff":

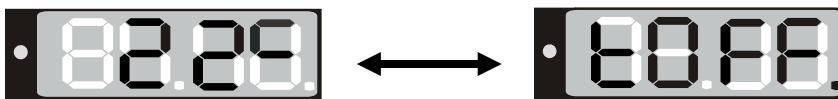

5.2 Heating operation display

The heating and fan (with FD) are active as soon as the red heating control light in the bottom right corner of the display slowly begins to flash depending on the heat requirement (example: 70 °C).



5.3 Air change

Opening the air flap in the outgoing air pipe serves to adjust the air change.

Without connecting a suction plant:

- For BD and ED units fresh air circulation can be elevated using the outgoing air pipe. The air flap in the outgoing air pipe serves to adjust the fresh air entry.
- For FD units with the air flap open and the fan operating, fresh air comes in via aeration gaps.
- If the air flap is completely open, the spatial temperature accuracy can be negatively influenced.

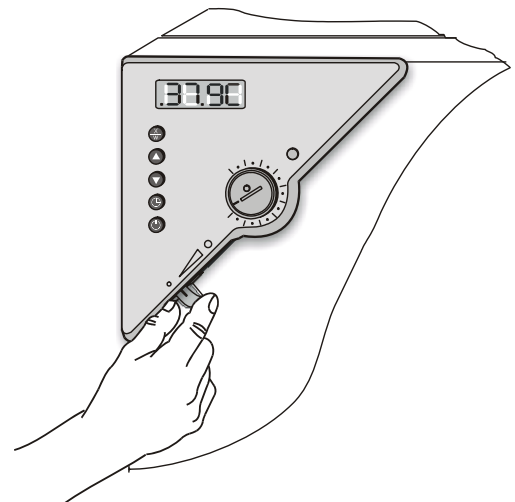

Figure 4: Adjusting the air flap

6. Controller setting

6.1 Display / entry of temperature set-point (without ramp function)

Controller setting is identical on both the ED/FD and the BD. The temperature controllers only differ in their temperature range.



The unit is operating, the controller is in normal display (actual value display). The actual temperature value (example: 22 °C) is displayed:

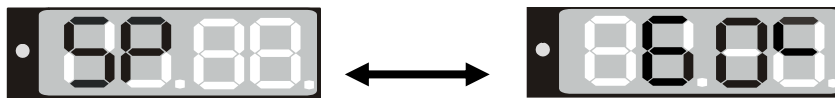

1. Press  button

The display shows alternately "SP" and in the entry level the previous **temperature set-point** (example: 60 °C):



2. With the   buttons enter a set-point value between 0 and 300.



The desired temperature set-point can be selected in a temperature range from 5 °C / 9 °F above room temperature up to 100 °C / 212 °F (BD) or 300 °C / 572 °F (ED/FD).



If you want to frequently operate heating ovens ED and FD at low set-points up to 70 °C, the controller parameters can be optimized accordingly. Please contact BINDER Service to obtain detailed instructions how to change the parameters.

3. Wait 2 seconds until the entered temperature value is taken over (display flashing once).
4. Press  button to return to normal display (actual value display) (automatically after 60 seconds).

6.2 Display / entry of temperature set-point (with selected temperature ramp)

If previously a temperature ramp value has been selected (chap. 6.4.2):

Press button  in normal display / actual value display during ramp operation to have displayed the actual temperature set-point changing according to the selected gradient in addition to the entered set-point for temperature.

The oven is operating, the controller is in normal display (actual value display). The **actual temperature value** (example: 22 °C) is displayed:



1. Press  button

The display shows alternately "SPr" and in the entry level the **actual temperature set-point** changing according to the selected gradient (example: 42 °C):

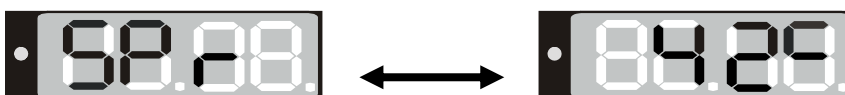



This ramp set-point is only displayed, not adjustable.

2. Press  button

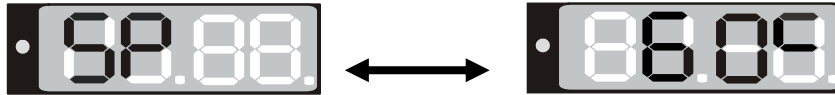
The display shows alternately "SP" and in the entry level the previous **temperature set-point** (example: 60 °C):



3. With the   buttons enter a set-point value between 0 and 300.

 The desired temperature set-point can be selected in a temperature range from 5 °C / 9 °F above room temperature up to 100 °C / 212 °F (BD) or 300 °C / 572 °F (ED/FD).

 If you want to frequently operate heating ovens ED and FD at low set-points up to 70 °C / 158 °F, the controller parameters can be optimized accordingly. Please contact BINDER Service to obtain detailed instructions how to change the parameters.

4. Wait 2 seconds until the entered temperature value is taken over (display flashing once).
5. Press  button to return to normal display / actual value display (automatically after 60 seconds).

6.3 Time functions: Continuous operation and Timer operation

Press the time management button .

The timer indicates its current time function. There are two possible time functions:

Continuous operation

The display shows alternately "t1" (time function) and the time function "Continuous operation" "t inf":



The heating and fan (with FD) are permanently active, independent of the timer setting.

Timer operation

The display shows alternately "t1" (time function) and the running-down time or "tOff":

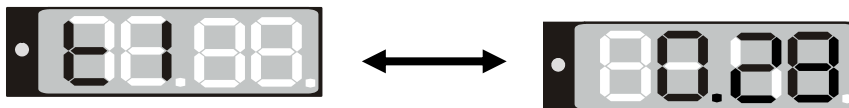

or



Remaining time (example: 28 Min.) – **Timer running down**

Heating and fan (with FD) are active until the timer has run-down.

Timer not programmed or run-down "t off"

If the timer has run-down, heating and fan (with FD) are permanently off.

Press  button to return to normal display (actual value display) (automatically after 60 seconds).

6.3.1 Switching between Continuous operation and Timer operation

Press the time management button .

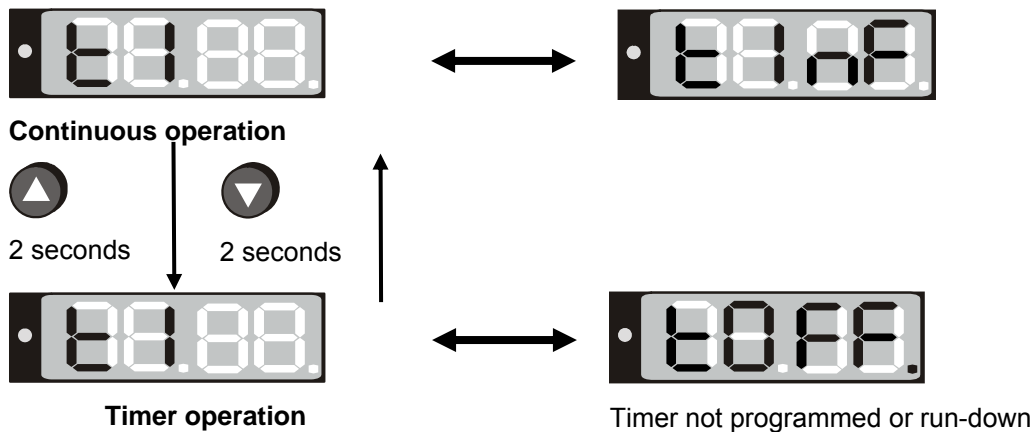

The controller displays the actual time function. In time function "Continuous operation", "t1" and "t inf" are displayed alternately. In time function "Timer operation", "t1" is displayed alternately with the running-down time or "tOff".

If in time function "Timer operation" the Timer is just running off ("t1" displayed alternately with the running-down time) the timer must first be set to Zero (chap. 6.3.3). Now "t1" is displayed alternately with "tOff", and the controller can be changed to time function "Continuous operation".





Press  button to return to normal display / actual value display (automatically after 60 sec).

6.3.2 Continuous operation

1. Press the time management button . The timer indicates its current time function.
2. If necessary, switch to timer operation by button .

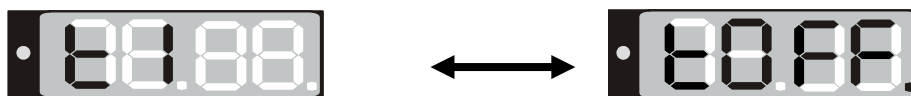
The display shows alternately "t1" and the time function "Continuous operation" "t inf":





3. Press  button to return to normal display (actual value display) (automatically after 60 seconds).

The **actual temperature value** (example: 22 °C) is displayed:



Now the controller operates with the entered set-point (chap. 6.1) in continuous operation. The heating and fan (for FD) are permanently active, independent of the timer setting.

To cancel Continuous operation, proceed accordingly:

1. Press the time management button .
2. Switch to Timer operation by pressing down button  for 2 seconds (chap. 6.3.1).

6.3.3 Timer operation: Setting the tempering time

1. Press the time management button . The controller indicates its current time function.

2. If necessary, switch to timer operation by button .

The display alternately shows "t1" and in the entry level the running-down **time** or "tOff":





or

Remaining time (example: 28 minutes) – Timer running down



Timer not programmed or run-off "t off"

3. Set the desired time [hh.mm] with buttons   in the entry level.

4. Wait 2 seconds until the entered temperature value is taken over (display flashing once).

The display alternately shows "t1" and the set time now running down.



The time directly begins to run off after taking-over of the entered value. Heating and fan (with FD) are active until the timer has run-down.

5. Press button  to return to normal display (actual value display) (automatically after 60 seconds).

The **actual temperature value** is displayed (example: 22 °C):



The controller operates with the entered set-points (chap. 6.1) until run-down of the set time. Heating and fan (with FD) are active until the timer has run-down.

To know the remaining timer time or, if appropriate, to modify it, press the time management button  in normal display (actual value display).

The display alternately shows "t1" and in the entry level running-down **time**:



After the set time has run down the display alternately shows the **actual temperature value** (example: 22 °C) and "tOff":



Now the heating and fan (with FD) are inactive.

6.4 User level settings

By pressing down button  in normal display (actual value display) for 5 sec, you enter the user menu. Settings in this menu affect controller operation.

User level overview:

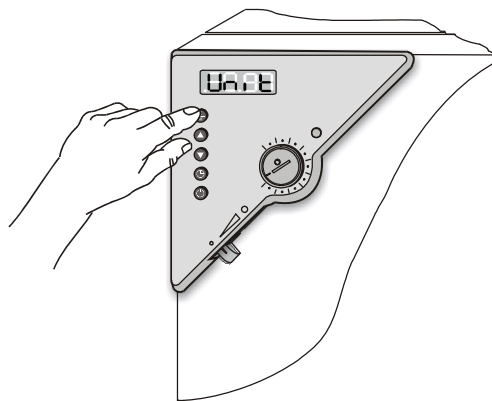
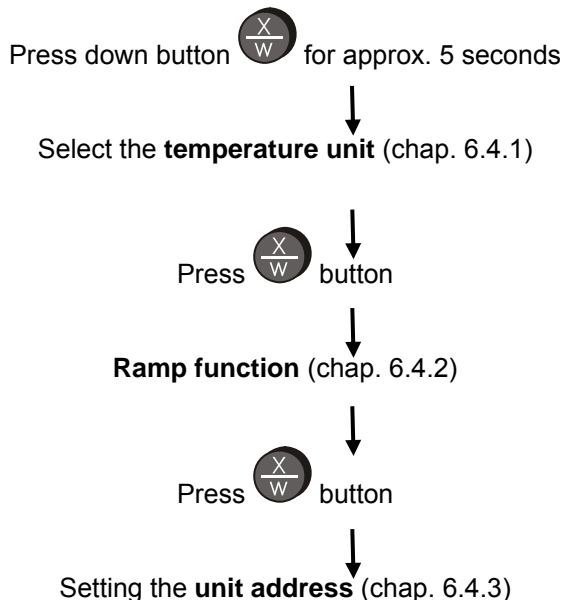



Figure 5: Press down  button for approx. 5 seconds

Press button  to return to normal display with display of the temperature set-point. **Or:**

After 60 seconds the controller automatically returns to normal display / actual value display.

All settings can be carried out independently (as described in the individual sections) or one after the other during one single process.



The defined parameters are not deleted when the main power switch is turned off or in case of power failure.



6.4.1 Temperature unit change between degrees Celsius °C and degrees Fahrenheit °F

If required, the temperature display can be changed as follows:

1. Press down  button for approx. 5 seconds.

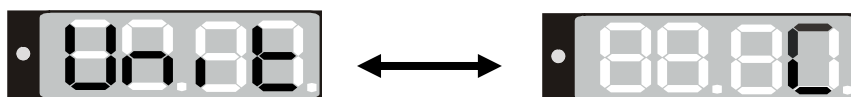
The display alternately shows "unit" and in the entry level the actual setting of the **temperature unit**:



2. Use the   buttons to set the required unit.
3. The set unit is automatically adopted after 2 seconds.



C = degrees Celsius	0 °C = 31 °F	Conversion:
F = degrees Fahrenheit	100 °C = 212 °F	[Value in °F] = [Value in °C] * 1.8 + 32

When specifying the set point ramp (see chap. 6.4.2) this setting is accordingly taken as the basis.



If the unit is changed, the temperature set-point and limits are converted accordingly.

6.4.2 Enter a temperature ramp

Temperature ramps can be programmed in order to extend heating up times. This may be necessary in some cases, in order to prevent temperature stresses in the material during the heating up phase. Temperature ramps should only be used if required. The use of temperature ramps may result in the heating up times being considerably slowed down.

The entry in °C/min or in °F/min meaning the nominal value gradient and limits the maximum temperature increase to this value. Due to the heat and evaporation energy assumed by the drying material, smaller temperature gradients may also result.

A temperature ramp proceeds from the previously entered to a new set-point. The temperature must have adjusted to the start set-point. Enter settings in 3 steps:

1. Enter set-point of ramp start temperature. Let temperature adjust to this set-point temperature.
2. Set ramp to the desired gradient. You can set the gradient from 0.0 °C/min up to 1.0 °C/min (BD), resp. from 1 °C/min up to 10 °C/min (ED, FD).

A heat-up rate of 0.4°/min (BD) resp. 4 °C/min. (ED, FD) can be regarded as a realistic maximum.

3. Enter set-point (final ramp temperature).

The ramp should only be set if required. The setting "0" means ramp function turned off. The unit is being heated at maximum heat output.

1. Press down  button for approx. 5 seconds.

The display alternately shows "unit" and in the entry level the temperature unit:

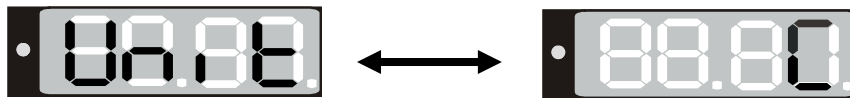

2. Press again button .

The display alternately shows "rASd" and in the entry level the actual setting of the **set-point gradient**:

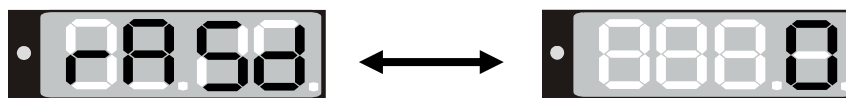

3. Set the desired ramp gradient with buttons   (set-point gradient in °F or °C acc. to setting in chap. 6.4.1).
4. The set value is automatically adopted after 2 seconds.

During ramp operation the actual set-point (SP_r) continually rises in accordance to the entered gradient from the previously entered set-point to the new one (SP). The actual value follows the set-point value.

About set-point display during ramp operation see chap. 6.2.

6.4.3 Chamber addressing

If several incubators BD or heating ovens ED (option) are networked with a PC via the APT-COM communication software (option, chap. 8.2), each unit must be allocated a unique address. Addressing takes place on the R 3 controller as follows:

1. Press down  button for approx. 5 seconds.

The display alternately shows "unit" and in the entry level the temperature unit:

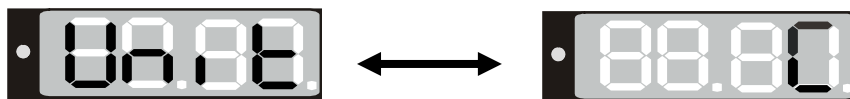

2. Press again button .

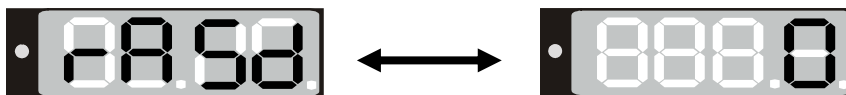

The display alternately shows "rASd" and in the entry level the set-point gradient:

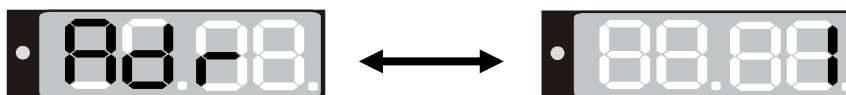

3. Press again button .

The display alternately shows "Adr" and in the entry level the actual setting of the **unit address**:



4. Set the required address with buttons  .



You can enter address values between 1 and 30.

5. The set value is automatically adopted after 2 seconds.

6.5 General notes





60 sec. after the last entry the controller returns to normal display (actual value display).



The functions set-point entry (chap. 6.1), time functions (chap. 6.3), and calling up the user menu (chap. 6.4) can only be selected from normal display (actual value display).



When selecting the functions set-point entry and time functions, and when selecting the user menu functions, the respective button  or  must be pressed down for a about 1 sec. Shorter pressing will be ignored by the controller.



After a power failure, the timer returns to the previous status. A remaining time, if any, will continue running down.

7. Safety devices

7.1 Temperature safety device class 2 (DIN 12880) ED, FD

The temperature safety device class 2 protects the unit, its environment and the charging material against impermissible excess temperatures.

Please also observe the regulations BGR 120 of the German professional association of the chemical industry (formerly ZH 1/119 laboratory guidelines of the employers' liability insurance association) (for Germany).

In the event of a fault in the temperature controller, the safety device (7) **permanently** turns off the unit. This status is reported visually by the indicator lamp (7a) and, in case of the option audible alarm with activated buzzer (chap. 8.1), by the buzzer sounding.

The operation of the safety device (7) is checked by moving it slowly anti-clockwise until it is turned off. The safety device cut-off is reported visually by the indicator lamp (7a) and, in case of the option audible alarm with activated buzzer (chap. 8.1), by the buzzer sounding.

The safety device is then released again by pressing the reset button (7b) and the unit is turned on as described.

Function:

The safety thermostat class 2 is functionally and electrically independent of the temperature control device and turns off **permanently** at all poles.

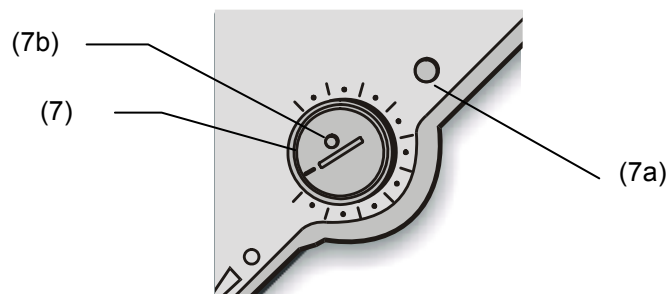

Figure 6: Safety thermostat class 2

When the control knob (7) is set to the end stop, the safety thermostat class 2 acts as a unit protection device. If it is set somewhat higher than the nominal temperature selected on the controller, it acts as a material protection device.

When the safety device has turned off the unit, which can be seen from the illumination of the red alarm lamp (7a) and, in case of the option audible alarm with activated buzzer (chap. 8.1), by the buzzer sounding, perform the following steps:

- Disconnect the unit from the power supply.
- Have the cause of the fault examined and rectified by a technician.
- Release safety thermostat class 2 by pressing reset button (7b).
- Restart the unit as described in chap. 5.

Setting:

In order to check at which temperature the safety device activates, start the unit and set the required nominal value on the temperature controller.

The scale division from 1 to 10 corresponds to the temperature range from 30 °C / 86 °F up to 320 °C / 608 °F and serves as a setting aid.

1. Turn the control knob (7) of the safety device using a coin to its end-stop (position 10) (unit protection).
2. When the set point is reached, turn back the control knob (7) until its trip point (turn it anti-clockwise).
3. The trip point is identifiable by the red alarm lamp (7a) lighting up; the reset button (7b) jumps out.

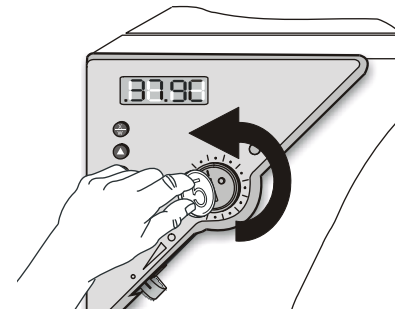

With the option audible alarm and the buzzer activated (chap. 8.1), the buzzer sounds as an additional signal. It can be turned off by switch (11).

4. The optimum setting of the safety device is obtained by turning the knob clockwise by around one graduation mark on the scale.
5. Push the reset button (7b) in again.

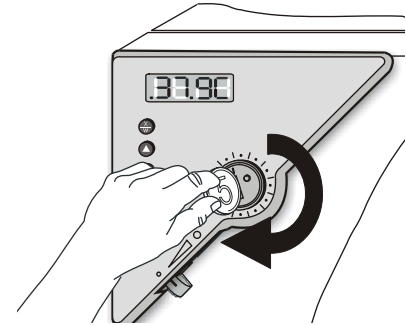

The unit is only active with the reset button (7b) pushed in.

When the safety thermostat class 2 kicks in, the red alarm lamp (7a) illuminates, the reset button (7b) jumps out and the unit turns off permanently at all poles.



Check the safety thermostat with every change of the set point value and readjust it if necessary.

7.2 Temperature safety device class 3.1 (DIN 12880) BD (option ED, FD)

The temperature safety device serves to protect the incubator, its environment and the contents from forbidden temperature excesses.

Please also observe the regulations BGR 120 of the German professional association of the chemical industry (formerly ZH 1/119 laboratory guidelines of the employers' liability insurance association) (for Germany).

Function:

The temperature safety device is functionally and electrically independent of the temperature control system and if an error occurs it assumes the regulatory function.

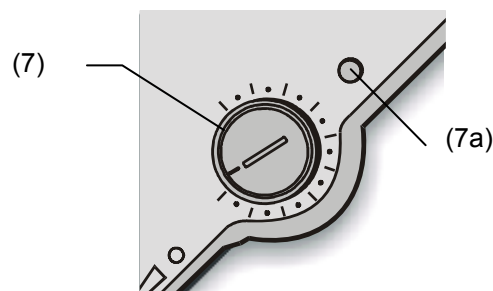

Figure 7: Safety thermostat class 3.1

If the control knob is turned to its end-stop, the safety thermostat class 3.1 functions as a safety device for the unit. If it is set to a temperature somewhat higher than that selected on the control, it functions as a protective device for the material under treatment.

If the safety device has assumed the regulation function (identifiable by the red alarm lamp (7a) lighting up and, in case of the option audible alarm with activated buzzer (chap. 8.1), by the buzzer sounding), proceed as follows:

- Disconnect the unit from the power supply.
- Have the cause of the fault examined and rectified by a technician.
- Restart the unit (see chapter 5).

Adjustment:

To check the response temperature of the safety thermostat class 3.1, turn on the unit and set the desired set point on the temperature controller.

The scale division from 1 to 10 corresponds to the temperature range from 0 °C / 32 °F to 120 °C / 248 °F (BD) or from 63 °C to 350 °C (ED or FD, option) and serves as a setting aid.

1. Turn the control knob (7) of the safety thermostat class 3.1 with a coin to its end-stop (unit protection).
2. When the set point is reached, turn the control knob (7) to its trip point (turn it anti-clockwise)
3. The trip point is identifiable by the red alarm lamp (7a) lighting up.
With the option audible alarm and the buzzer activated (chap. 8.1), the buzzer sounds as an additional signal. It can be turned off by switch (11).
4. The optimum setting for the safety thermostat class 3.1 is obtained by turning the control knob clockwise by approximately one scale division, which extinguishes the red alarm lamp (7a).

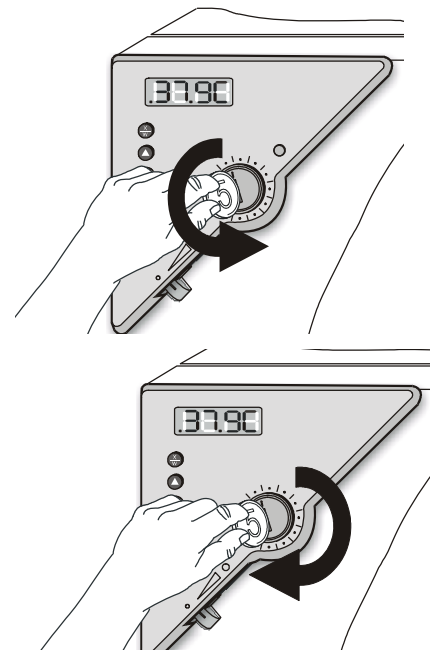

Check the safety thermostat with every change of the set point value and readjust it if necessary.

8. Options

8.1 Disconnectable audible over-temperature alarm (option)

This option permits activating an audible signal with the buzzer switch (11):

Position 0 = buzzer off

Position 1 = buzzer active

If the buzzer is activated, an audible signal sounds when the limit temperature set at the temperature safety device class 2 (chap. 7.1) or class 3.1 (chap. 7.2) is exceeded, this happens in addition to the red alarm pilot lamp (7a) lighting up. The buzzer can be turned off using the buzzer switch (11).



Turning off the audible alarm does not influence the safety device's regulatory function. Proceed as described in chap. 7.1 / 7.2.

8.2 Communication software APT-COM™ 3 DataControlSystem (BD, option ED)

The oven is regularly equipped with a serial interface RS 422 that can connect the BINDER communication software APT-COM™ 3 DataControlSystem. The connection to a computer is established using the unit interface via an interface converter RS 422 / RS 232.

The actual temperature values are given at adjustable intervals. Programming can be performed graphically via PC. Up to 30 chambers with RS 422 interface can be cross linked. For further information, refer to the operating manual of the BINDER communication software APT-COM™.

	pin 2: RxD (+)
Pin allocation of the RS 422 interface:	pin 3: TxD (+)
	pin 4: RxD (-)
	pin 5: TxD (-)
	pin 7: Ground



If several incubators BD or heating ovens ED (option) are to be recorded via a PC, each one must be allocated a unique address. Addressing is performed via the R3 controller (see chap. 6.4.3).

8.3 Analog output for temperature (option)

With this option the chamber is equipped with an analog output 4-20 mA for temperature. This output permits transmitting data to external data registration systems or devices.

The connection is carried out as a DIN socket at the rear of the chamber as follows:

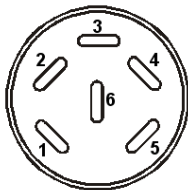

ANALOG OUTPUT 4-20 mA DC

PIN 1: Temperature –

PIN 2: Temperature +

Temperature range:

BD: 0 °C / 32 °F to +100 °C / 212 °F

ED, FD: 0 °C / 32 °F to +300 °C / 572 °F

A suitable DIN plug is enclosed.

Figure 8: Pin allocation of DIN socket for option analog outputs

8.4 Additional Pt100 temperature sensor (option BD)

An additional fixed or flexible temperature sensor Pt100 permits measuring the chamber temperature (fixed Pt100) or the temperature of the charging material (flexible Pt100) by means of an independent measuring system with Pt100 entry. The sensor top protective tube of the flexible Pt100 can be immersed into liquid substances.

Technical data of the Pt100 sensor:

- Three-wire technique
- Class B (DIN EN 60751)
- Temperature range up to 320 °C / 608 °F
- Stainless steel protective tube 45 mm length material no. 1.4501

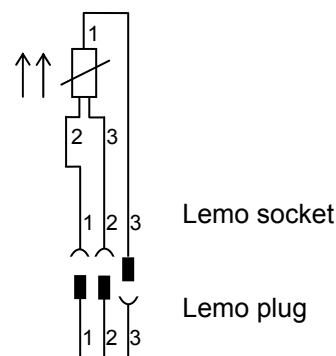

Figure 9: Option temperature sensor Pt100



8.5 Water protected internal socket (option BD)

The internal socket is splash proof.

IP system of protection 65 230 V 1N ~ 50-60 Hz

Charge max. 500 W

Maximum permitted operating temperature with this option: 50 °C / 122 °F.



	 WARNING
	<p>Exceeding of the permitted maximum temperature.</p> <p>Electrical hazard.</p> <p>Danger of death.</p> <p>Damage to the internal socket.</p> <ul style="list-style-type: none"> ⊘ Do NOT exceed the temperature set-point of 50 °C / 122 °F. ➤ Set the mechanical thermostat class 3.1 to 50 °C / 122 °F.

	Heat emission of electrical devices connected inside the chamber may modify the temperature range.
---	--

	CAUTION
	<p>Risk of short circuit.</p> <p>Damage to the unit.</p> <ul style="list-style-type: none"> ➤ Use the delivered plug only (IP protection type 66). Plug-in the plug and turn it to secure. ➤ If the socket is not used, close the lift-up lid and turn it for securing.

9. Maintenance, cleaning, and service

9.1 Maintenance intervals, service

 	 DANGER
	<p>Electrical hazard.</p> <p>Danger of death.</p> <ul style="list-style-type: none"> ⊘ The unit must NOT become wet during operation or maintenance work. ⊘ Do NOT remove the rear panel of the unit. ➤ Disconnect the unit before conducting maintenance work. Disconnect the power plug. ➤ Ensure all maintenance work is conducted by licensed electricians or experts authorized by BINDER.

Ensure regular maintenance work is performed at least once a year.





	Replace the door gasket only when cold. Otherwise, the door gasket may become damaged.
---	--

We recommend taking out a maintenance agreement. Please consult BINDER Service.

BINDER telephone hotline:	+49 (0) 7462 2005 555
BINDER fax hotline:	+49 (0) 7462 2005 93555
BINDER e-mail hotline:	service@binder-world.com
BINDER service hotline USA:	+1 866 885 9794 or +1 631 224 4340 (toll-free in the USA)
BINDER service hotline Spain:	+34 9492 677 23
BINDER service hotline Asia Pacific:	+852 39070500 or +852 39070503
BINDER service hotline Russia and CIS:	+7 495 98815 17
BINDER Internet website:	http://www.binder-world.com
BINDER address:	BINDER GmbH, post office box 102, D-78502 Tuttlingen

International customers, please contact your local BINDER distributor.

9.2 Cleaning and decontamination

  	 DANGER
	<p>Electrical hazard.</p> <p>Danger of death.</p> <ul style="list-style-type: none"> ∅ Do NOT spill water or cleaning agents over the inner and outer surfaces. ➤ Disconnect the unit before cleaning. Disconnect the power plug. ➤ Completely dry the appliance before turning it on again.

Cleaning

Disconnect the chamber from the power supply before cleaning. Disconnect the power plug.

Wipe the surfaces with a moistened towel. In addition, you can use the following cleaning agents:

Exterior surfaces inner chamber racks door gaskets	Standard commercial cleaning detergents free from acid or halogenides. Alcoholic solutions. We recommend using the neutral cleaning agent Art. No. 1002-0016.
Instrument panel	Standard commercial cleaning detergents free from acid or halogenides. We recommend using the neutral cleaning agent Art. No. 1002-0016.

	<p>For surface protection, perform cleaning as quickly as possible.</p> <p>After cleaning completely remove cleaning agents from the surfaces with a moistened towel.</p>
---	---

	<p>Soapsuds may contain chlorides and must therefore NOT be used for cleaning.</p>
---	--

Decontamination

Disconnect the chamber from the power supply prior to decontamination. Pull the power plug.

You can use the following disinfectants:

Inner chamber	Standard commercial surface disinfectants free from acid or halogenides. Alcoholic solutions. We recommend using disinfectant Art. No. 1002-0022.
---------------	---

In case of impurity of the interior with biological or chemical hazardous material, there are three possible procedures depending on the type of contamination and of the charging material.

1. The heating ovens ED and FD can be hot air sterilized at 190 °C / 374 °F for at least 30 minutes. All inflammable goods must be removed from the interior before. With the incubators BD it is possible to perform a hot-air disinfection at 100 °C / 212 °F.

2. Spray the inner chamber with an appropriate disinfectant.

Before start-up, the unit must be absolute dry and ventilated, because explosive gases may form during the decontamination process.

3. If necessary, have strongly contaminated inner chamber parts removed by an engineer for cleaning, or have them exchanged. Sterilize the inner chamber parts in a sterilizer or autoclave.

	With every decontamination method, always use adequate personal safety controls.
---	--

	CAUTION
	<p>Danger of corrosion.</p> <p>Damage to the unit.</p> <p>∅ Do NOT use acidic or chlorine cleaning detergents.</p>

	<p>We recommend using the neutral cleaning agent Art. No. Art. Nr. 1002-0016 for a thorough and mild cleaning.</p> <p>Any corrosive damage that may arise following use of other cleaning agents is excluded from liability by BINDER GmbH.</p>
--	---

9.3 Sending the unit back to BINDER GmbH

If you return a BINDER product to us for repair or any other reason, we will only accept the product upon presentation of an authorization number that has previously been issued to you. An authorization number will be issued after receiving your complaint either in writing or by telephone **prior** to your sending the BINDER product back to us. The authorization number will be issued following receipt of the information below:

- BINDER product type and serial number
- Date of purchase
- Name and address of the dealer from which you bought the BINDER product
- Exact description of the defect or fault
- Complete address, contact person and availability of that person
- Exact location of the BINDER product in your facility
- A contamination clearance certificate (chap. 13) must be faxed in advance

The authorization number must be applied to the packaging in such a way that it can be easily recognized or be recorded clearly in the delivery documents.

	For safety reasons we cannot accept a unit delivery if it does not carry an authorization number.
---	---

10. Disposal

10.1 Disposal of the transport packing

Packing element	Material	Disposal
Straps to fix packing on pallet	Plastic	Plastic recycling
Wooden transport box (option)	Non-wood (compressed matchwood, IPPC standard)	Wood recycling
with metal screws	Metal	Metal recycling
Pallet (from size 115 on) with foamed plastic stuffing (from size 240 on)	Solid wood (IPPC standard)	Wood recycling
Transport box with metal clamps	Cardboard	Paper recycling
	Metal	Metal recycling
Removal aid (sizes 240 and 400 only)	Cardboard	Paper recycling
	Plastic	Plastic recycling
Edge protection	Styropor® or PE foam	Plastic recycling
Protection of doors and racks	PE foam	Plastic recycling
Bag for operating manual	PE foil	Plastic recycling
Insulating air cushion foil (packing of optional accessories)	PE foil	Plastic recycling

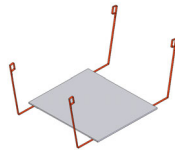

If recycling is not possible, all packing parts can also be disposed of with normal waste.

10.2 Decommissioning

Turn off ED units sizes 400 and 720 at the main power switch (10). Disconnect the unit from the power supply.



When turning off the main power switch ON / OFF (10), the stored parameters remain saved.

- Temporal decommissioning: See indications for appropriate storage, chap. 3.3.
- Final decommissioning: Dispose of the unit as described in chap. 10.3 to 10.5.

10.3 Disposal of the unit in the Federal Republic of Germany

According to directive 2002/96/EC of the European Parliament and of the Council on waste electrical and electronic equipment (WEEE), BINDER devices are classified as “monitoring and control instruments” (category 9) only intended for professional use“. They must not be disposed of at public collecting points.

The incubators BD and heating ovens ED and FD bear the symbol for the marking of electrical and electronic equipment manufactured / placed on the market in the EC after 13 August 2005 and be disposed of in separate collection according to the directive 2002/96/EC on waste electrical and electronic equipment (WEEE) and German national law for electrical and electronic equipment (Elektro- und Elektronikgerätegesetz, ElektroG). WEEE marking: crossed-out wheeled bin with solid bar under. A significant part of the materials must be recycled in order to protect the environment.

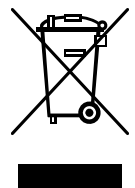



At the end of the device's service life, have the device disposed of according to the German national law for electrical and electronic equipment (Elektro- und Elektronikgerätegesetz, ElektroG) from 23 March 2005, BGBl. I p. 762 or contact BINDER Service who will organize taking back and disposal of the unit according to the German national law for electrical and electronic equipment (Elektro- und Elektronikgerätegesetz, ElektroG) from 23 March 2005, BGBl. I p. 762.

	CAUTION
	<p>Violation against existing law.</p> <ul style="list-style-type: none"> ⊘ Do NOT dispose of BINDER devices at public collecting points. ➤ Have the device disposed of professionally at a recycling company that is certified according to the German national law for electrical and electronic equipment (Elektro- und Elektronikgerätegesetz, ElektroG) from 23 March 2005, BGBl. I p. 762. <li style="text-align: center;"><i>or</i> ➤ Instruct BINDER Service to dispose of the device. The general terms of payment and delivery of BINDER GmbH apply, which were valid at the time of purchasing the unit.

Certified companies disassemble waste BINDER equipment in primary substances for recycling according to directive 2002/96/EC by. The devices must be free from toxic, infectious or radioactive substances in order to eliminate any health hazards to the employees of the recycling companies.

	<p>Prior to handing the unit over to a recycling company, it is the user's responsibility that it is free from toxic, infectious or radioactive substances.</p> <ul style="list-style-type: none"> • Prior to disposal, clean all introduced or residual toxic substances from the unit. • Prior to disposal, disinfect the unit from all sources of infection. Be aware of the fact that sources of infection may also be located outside the inner chamber. • If you cannot safely remove all toxic substances and sources of infection from the unit, dispose of it as "special" waste according to national law. • Fill out the contamination clearance certificate (chap. 13) and enclose it with the unit.
---	--

 	WARNING
	<p>Contamination of the device with toxic, infectious or radioactive substances.</p> <p>Danger of intoxication.</p> <p>Danger of infection.</p> <ul style="list-style-type: none"> ⊘ NEVER take a unit contaminated with toxic substances or sources of infection for recycling according to directive 2002/96/EC. ➤ Prior to disposal, remove all toxic substances and sources of infection from the unit. ➤ Dispose of a unit from which all toxic substances or sources of infection cannot be safely removed as special waste according to national law.

10.4 Disposal of the unit in the member states of the EC except for the Federal Republic of Germany

According to directive 2002/96/EC of the European Parliament and of the Council on waste electrical and electronic equipment (WEEE), BINDER devices are classified as “monitoring and control instruments” (category 9) only intended for professional use“. They must not be disposed of at public collecting points.

The incubators BD and heating ovens ED and FD bear the symbol for the marking of electrical and electronic equipment manufactured / placed on the market in the EC after 13 August 2005 and be disposed of in separate collection according to the directive 2002/96/EC on waste electrical and electronic equipment (WEEE). WEEE marking: crossed-out wheeled bin with solid bar under.

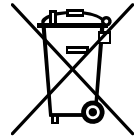



At the end of the device’s service life, notify the distributor who sold you the device, who will take back and dispose of the unit according to the directive 2002/96/EC of 27 January 2003 on waste electrical and electronic equipment (WEEE).



	CAUTION
	<p>Violation against existing law.</p> <ul style="list-style-type: none"> ⊘ Do NOT dispose of BINDER devices at public collecting points. ➤ Have the device disposed of professionally at a recycling company that is certified according to conversion of the directive 2002/96/EC into national law. <li style="text-align: center;"><i>or</i> ➤ Instruct the distributor who sold you the device to dispose of it. The agreements apply that were reached with the distributor when purchasing the unit (e.g. his general terms of payment and delivery). ➤ If your distributor is not able to take back and dispose of the unit, please contact BINDER service.

Certified companies disassemble waste BINDER equipment in primary substances for recycling according to directive 2002/96/EC. The devices must be free from toxic, infectious or radioactive substances in order to eliminate any health hazards to the employees of the recycling companies.

	<p>Prior to handing the unit over to a recycling company, it is the user’s responsibility that it is free from toxic, infectious or radioactive substances.</p> <ul style="list-style-type: none"> • Prior to disposal, clean all introduced or residual toxic substances from the unit. • Prior to disposal, disinfect the unit from all sources of infection. Be aware of the fact that sources of infection may also be located outside the inner chamber. • If you cannot safely remove all sources of infection and toxic substances from the unit, dispose of it as “special” waste according to national law. • Fill out the contamination clearance certificate (chap. 13) and enclose it with the unit.
---	--

 	 WARNING
	<p>Contamination of the device with toxic, infectious or radioactive substances.</p> <p>Danger of intoxication.</p> <p>Danger of infection.</p> <ul style="list-style-type: none"> ⊘ NEVER take a unit contaminated with toxic substances or sources of infection for recycling according to directive 2002/96/EC. ➤ Prior to disposal, remove all toxic substances and sources of infection from the unit. ➤ Dispose of a unit from which all toxic substances or sources of infection cannot be safely removed as “special” waste according to national law.

10.5 Disposal of the unit in non-member states of the EC

 	CAUTION
	<p>Alteration of the environment.</p> <ul style="list-style-type: none"> ➤ For final decommissioning and disposal of the oven, please contact BINDER Service. ➤ Follow the statutory regulations for appropriate, environmentally friendly disposal.

The main board of the oven includes a lithium cell. Please dispose of it according to national regulations.

11. Troubleshooting

Fault description	Possible cause	Required measures
Temperature		
Set-point temperature is not reached after specified time.	Unit door not properly closed.	Completely close unit door.
	Door gasket defective.	Replace door gasket,
	Controller not adjusted, or adjustment interval exceeded.	Calibrate and adjust controller.
	Wrong voltage.	Check power supply for voltage of 115V or 230V.
<i>FD</i> : The fan doesn't turn or turns too slowly.	Fan defective.	Contact BINDER service.
Chamber heating permanently, set-point not held.	Controller defective.	Contact BINDER service.
	Pt 100 sensor defective.	
	Semiconductor relay defective	
	Controller not adjusted, or adjustment interval exceeded.	Calibrate and adjust controller.
Chamber doesn't heat up. Red heating control light in the display is lit.	Heating element defective.	Contact BINDER service.
	Semiconductor relay defective.	
Chamber doesn't heat up. Red heating control light in the display is not lit. Controller display working.	Timer run off.	Program the timer or change to time function Continuous operation (chap. 6.3)
	Semiconductor relay defective.	Contact BINDER service.
	Controller defective.	
Unit without function, only the green "stand-by" LED is lit	Unit in stand-by mode	Press down the ON/OFF button (5) until the display lights up.
<i>BD, option ED, FD</i> : Temperature inside the chamber too high, Red alarm pilot lamp of safety device (7a) is lit..	Safety device class 3.1 has responded.	Check the settings of the temperature set-point and of the safety device class 3.1 (chap. 7.2).
<i>ED, FD</i> : Unit without function. Red alarm pilot lamp of safety device (7a) is lit.	Safety device class 2 has turned off the chamber.	Let cool down the chamber and press down RESET button. Check the settings of the temperature set-point and of the safety device class 2 (chap. 7.1). If appropriate, select suitable limit value.
	Safety device class 2 defective.	Contact BINDER service.

Fault description	Possible cause	Required measures
Temperature (continued)		
Unit without any function.	No power supply.	Check connection to power supply.
	Unit fuse has responded.	Check unit fuse and replace it if appropriate. If it responds again, contact BINDER service.
	Controller defective.	Contact BINDER service.
Deviations from the indicated heating-up times.	Oven fully loaded.	Charge the oven less or consider longer heating-up times.
Controller		
Message „1999” in the controller display	Sensor rupture between sensor and controller.	Contact BINDER service.
The controller returns to Normal Display from any level.	No button was hit for more than 60 sec.	Repeat entries, enter the values rapidly.



Only qualified service personnel authorized by BINDER must perform repair. Repaired units must comply with the BINDER quality standards.

12. Technical description

12.1 Factory calibration and adjustment

This unit was calibrated and adjusted in the factory. Calibration and adjustment were performed using standardized test instructions, according to the QM DIN EN ISO 9001 system applied by BINDER (certified since December 1996 by TÜV CERT). All test equipment used is subject to the administration of measurement and test equipment that is also constituent part of the BINDER QM DIN EN ISO 9001 systems. They are controlled and calibrated to a DKD-Standard at regular intervals.

12.2 Definition of usable volume

The usable volume illustrated below is calculated as follows:

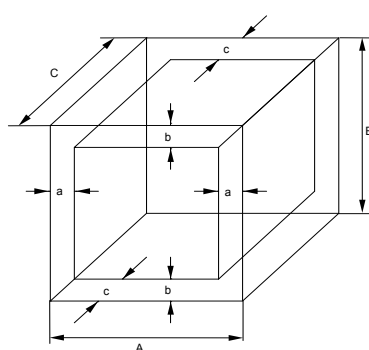

A, B, C = Internal dimensions (W, H, D)

a, b, c = Wall clearances

$$a = 0.1 \times A$$

$$b = 0.1 \times B$$

$$c = 0.1 \times C$$

$$V_{USE} = (A - 2a) \times (B - 2b) \times (C - 2c)$$

Figure 10: Determination of the useable volume

The technical data refers to the defined usable volume.



Do NOT place samples outside this usable volume.

Do NOT load this volume by more than half to enable sufficient airflow inside the chamber.

Do NOT divide the usable volume into separate parts with large area samples.

Do NOT place samples too close to each other in order to permit circulation between them and thus obtain a homogenous distribution of temperature.

12.3 Over current protection

Single-phase devices are protected by a miniature fuse against over current, accessible from the outside. The miniature fuse is located at the rear of the chamber below the strain relief of the power cord. The fuse holder is equipped with a fuse clip 5mm x 20 mm. (CUL-Version 6,3x32 mm). The fuse may be replaced only with a substitute of the same ratings. Refer to the technical data of the respective device type.

Three-phase devices are equipped with internal fuses not accessible from outside. If these fuses are blown, please inform an electronic engineer or BINDER service.

12.4 BD technical data

Unit size		BD 23	BD 53	BD 115	BD 240	BD 400	BD 720
Exterior dimensions							
Width	mm	435	635	835	1035	1235	1235
	inch	17.13	25.00	32.87	40.75	48.62	48.62
Height (incl. feet/castors)	mm	495	620	705	825	1025	1530
	inch	19.49	24.41	27.76	32.48	40.35	60.24
Depth	mm	520	575	645	745	765	865
	inch	20.47	22.64	25.39	29.33	30.12	34.06
incl. door handle and exhaust duct	mm	105	105	105	105	105	105
	inch	4.13	4.13	4.13	4.13	4.13	4.13
Wall clearance rear	mm	100	100	100	100	100	100
	inch	3.94	3.94	3.94	3.94	3.94	3.94
Wall clearance side	mm	100	160	160	160	160	160
	inch	3.94	6.30	6.30	6.30	6.30	6.30
Exhaust duct, outer diameter	mm	52	52	52	52	52	52
	inch	2.05	2.05	2.05	2.05	2.05	2.05
Steam space volume	l	36	70	142	283	457	808
	cu.ft.	1.27	2.47	5.02	10.0	16.15	28.55
Number of door(s)		1	1	1	2	2	2
Interior dimensions							
Width	mm	222	400	600	800	1000	1000
	inch	8.74	15.75	23.62	31.50	39.37	39.37
Height	mm	330	400	480	600	800	1200
	inch	12.99	15.75	18.90	23.62	31.50	47.24
Depth	mm	277	330	400	500	500	600
	inch	10.91	12.99	15.75	19.69	19.69	23.62
Interior volume	l	20	53	115	240	400	720
	cu.ft.	0.7	1.9	4.1	8.6	14.3	25.7
Quantity of racks (regular / max.)		2/3	2/4	2/5	2/7	2/10	2/15
Load per rack	Kg	12	15	20	30	35	45
	lbs	26	33	44	66	77	99
Permitted total load	Kg	25	40	50	70	90	120
	lbs	55	88	110	155	199	265
Weight (empty)	Kg	26	43	61	93	135	191
	lbs	57	95	135	205	298	422

Unit size			BD 23	BD 53	BD 115	BD 240	BD 400	BD 720
Temperature data								
Temperature range, 5 °C / 9 °F above ambient up to	°C		100	100	100	100	100	100
	°F		212	212	212	212	212	212
Temperature uniformity (variation 1)	at 37 °C	± K	0.5	0.5	0.4	0.5	0.5	0.5
	at 50 °C	± K	1.8	1.1	0.8	0.9	0.9	0.8
Temperature fluctuation	at 37 °C	± K	0.2	0.1	0.1	0.1	0.1	0.1
	at 50 °C	± K	0.3	0.1	0.1	0.1	0.1	0.1
Heating up time 2)	to 37 °C	Min	49	38	62	70	105	84
	to 50 °C	Min	51	59	91	115	132	90
Recovery time after door was opened for 30 sec 2)	at 37 °C	Min	3	5	5	5	6	4
	at 50 °C	Min	4	7	7	6	29	24
Electrical data								
IP system of protection acc. to EN 60529	IP		20	20	20	20	20	20
Nominal voltage (±10 %) 50/60 Hz	V		230 1N~	230 1N~	230 1N~	230 1N~	230 1N~	230 1N~
Nominal power	kW		0.2	0.4	0.4	0.68	0.85	1.25
Energy consumption at 37°C / 98.6°F	Wh/h		11	11	20	33	56	80
Unit fuse 5 x 20 mm 230V / 10A / middle-time-lag (M)	Amp		10 external	10 external	10 external	10 external	10 external	10 external
Power plug			shock proof plug					
Installation category acc. to IEC 61010-1			II	II	II	II	II	II
Pollution degree acc. to IEC 61010-1			2	2	2	2	2	2

Electrical connection data BD-UL acc. to cUL standard (for USA and Canada):

Unit size			BD 23-UL	BD 53-UL	BD 115-UL	BD 240-UL	BD 400-UL	BD 720-UL
Electrical data								
Nominal voltage (±10%) 60 Hz	V		115 1N~	115 1N~	115 1N~	115 1N~	115 1N~	115 1N~
Nominal power	kW		0.20	0.30	0.40	0.68	0.85	1.25
Nominal current	Amp		1.8	2.6	3.5	5.9	7.4	10.9
Power plug	NEMA		5-15P	5-15P	5-15P	5-15P	5-15P	5-20P
Unit fuse 6,3 x 32 mm 250V / super-time-lag TT	Amp		12,5 external	12,5 external	12,5 external	12,5 external	12,5 external	16 external
Additional temperature fuse class 1 (DIN 12880)			internal	internal	internal	internal	internal	internal

Legend: 1) without outer glass door 2) up to 98 % of the set value

All technical data is specified for units with standard equipment at an ambient temperature of +25 °C / 77 °F and a power supply voltage fluctuation of ±10. The temperature data is determined in accordance to BINDER factory standard following DIN 12880, observing the recommended wall clearances of 10 % of the height, width and depth of the inner chamber.

All indications are average values, typical for units produced in series. We reserve the right to change technical specifications at any time.

	If the cabinet is fully loaded, the specified heating up times may vary according to the load.
---	--

	With option interior socket: If electrical devices are connected and operating inside the chamber, the temperature range may be modified due to heat emission.
---	--

12.5 ED technical data

Unit size		ED 23	ED 53	ED 115	ED 240	ED 400	ED 720
Exterior dimensions							
Width	mm	435	635	835	1035	1235	1235
	inch	17.13	25.00	32.87	40.75	48.62	48.62
Height (incl. feet/castors)	mm	495	620	705	825	1025	1530
	inch	19.49	24.41	27.76	32.48	40.35	60.24
Depth	mm	520	575	645	745	765	865
	inch	20.47	22.64	25.39	29.33	30.12	34.06
incl. door handle and exhaust duct	mm	105	105	105	105	105	105
	inch	4.13	4.13	4.13	4.13	4.13	4.13
Wall clearance rear	mm	100	100	100	100	100	100
	inch	3.94	3.94	3.94	3.94	3.94	3.94
Wall clearance side	mm	100	160	160	160	160	160
	inch	3.94	6.30	6.30	6.30	6.30	6.30
Exhaust duct, outer diameter	mm	52	52	52	52	52	52
	inch	2.05	2.05	2.05	2.05	2.05	2.05
Steam space volume	l	36	70	142	283	457	808
	cu.ft.	1.27	2.47	5.02	10.0	16.15	28.55
Number of door(s)		1	1	1	2	2	2
Interior dimensions							
Width	mm	222	400	600	800	1000	1000
	inch	8.74	15.75	23.62	31.50	39.37	39.37
Height	mm	330	400	480	600	800	1200
	inch	12.99	15.75	18.90	23.62	31.50	47.24
Depth	mm	277	330	400	500	500	600
	inch	10.91	12.99	15.75	19.69	19.69	23.62
Interior volume	l	20	53	115	240	400	720
	cu.ft.	0.7	1.9	4.1	8.6	14.3	25.7
Quantity of racks (regular / max.)		2/3	2/5	2/6	2/7	2/10	2/15
Load per rack	Kg	12	15	20	30	35	45
	lbs	26	33	44	66	77	99
Permitted total load	Kg	25	40	50	70	90	120
	lbs	55	88	110	155	199	265
Weight (empty)	Kg	22	42	57	86	125	174
	lbs	49	93	126	190	276	384
Temperature data							
Temperature range, 5 °C / 9 °F above ambient up to		°C	300	300	300	300	300
		°F	572	572	572	572	572
Temperature uniformity (variation 1)	at 70 °C / 158 °F	± K	1.5	2	1.5	1.5	1.7
	at 150 °C / 302 °F	± K	2.5	3.2	2.5	2.5	3
	at 300 °C / 572 °F	± K	3.8	4.5	4.5	5.0	5.0
Temperature fluctuation		± K	0.3	0.3	0.3	0.3	0.3
Heating up time 2)	to 70 °C / 158 °F	Min	13	14	15	40	49
	to 150 °C / 302 °F	Min	24	27	29	48	62
	to 250 °C / 482 °F	Min	35	61	66	61	74
Recovery time after door was open for 30 sec 2)	at 70 °C / 158 °F	Min	2.5	2	2	5	4
	at 150 °C / 302 °F	Min	5	6	9	13	20
	at 300 °C / 572 °F	Min	8	11	14	18	24

Unit size			ED 23	ED 53	ED 115	ED 240	ED 400	ED 720
Ventilation data								
Air change	at 70 °C / 158 °F	x/h	10	8	12	11	11	10
	at 150 °C / 302 °F	x/h	13	12	10	10	10	9
	at 300 °C / 572 °F	x/h	17	20	10	9	9	8
Electrical data								
IP system of protection acc. to EN 60529			20	20	20	20	20	20
Nominal voltage (±10%) 50/60 Hz		V	230 1N~	230 1N~	230 1N~	230 1N~	400 3N~	400 3N~
Nominal power		kW	0.8	1.20	1.60	2.70	3.40	5.00
Energy consumption	at 70 °C / 158 °F	Wh/h	43	60	90	143	201	220
	at 150 °C / 302 °F	Wh/h	148	210	300	447	672	750
	at 300 °C / 572 °F	Wh/h	450	600	360	700	1000	1200
Unit fuse 5 x 20 mm / 230V / middle-time-lag (M)		Amp	10 external	10 external	10 external	16 external	3 x 16 internal	3 x 16 internal
Power plug			shock proof plug				CEE plug 5 poles	
Installation category acc. to IEC 61010-1			II	II	II	II	II	II
Pollution degree acc. to IEC 61010-1			2	2	2	2	2	2

Electrical connection data ED-UL acc. to cUL standard (for USA and Canada):

Unit size			ED 23- UL	ED 53- UL	ED 115- UL	ED 240- UL	ED 400- UL	ED 720- UL
Electrical data								
Nominal voltage (±10%) 60 Hz		V	115 1N~	115 1N~	115 1N~	208 3N~	208 3N~	208 3N~
Nominal power		kW	0.80	1.20	1.60	2.70	3.40	5.00
Nominal current		Amp	7.0	10.5	14.0	11.2	10.6	15.6
Power plug		NEMA	5-20P	5-20P	5-20P	L21-20P	L21-20P	L21-20P
Unit fuse 6,3 x 32 mm / 250V / super-time-lag TT		Amp	12.5 external	16 external	16 external	3 x 16 internal	3 x 16 internal	3 x 16 internal

Legend: 1) without outer glass door 2) up to 98 % of the set value

All technical data is specified for units with standard equipment at an ambient temperature of +25 °C / 77 °F and a power supply voltage fluctuation of ±10. The temperature data is determined in accordance to BINDER factory standard following DIN 12880, observing the recommended wall clearances of 10 % of the height, width and depth of the inner chamber.

All indications are average values, typical for units produced in series. We reserve the right to change technical specifications at any time.

	If the cabinet is fully loaded, the specified heating up times may vary according to the load.
---	--

12.6 FD technical data

Unit size		FD 23	FD 53	FD 115	FD 240
Exterior dimensions					
Width	mm / inch	435 / 17.13	635 / 25.00	835 / 32.87	1035 / 40.75
Height (incl. feet)	mm / inch	495 / 19.49	620 / 24.41	705 / 27.76	825 / 32.48
Depth	mm / inch	520 / 20.47	575 / 22.64	645 / 25.39	745 / 29.33
incl. door handle and exhaust duct	mm / inch	105 / 4.13	105 / 4.13	105 / 4.13	105 / 4.13
Wall clearance rear	mm / inch	100 / 3.94	100 / 3.94	100 / 3.94	100 / 3.94
Wall clearance side	mm / inch	100 / 3.94	160 / 6.30	160 / 6.30	160 / 6.30
Exhaust duct, outer diameter	mm / inch	52 / 2.05	52 / 2.05	52 / 2.05	52 / 2.05
Steam space volume	l / cu.ft.	36 / 1.27	77 / 2.72	158 / 5.58	308 / 10.88
Number of door(s)		1	1	1	2

Unit size		FD 23	FD 53	FD 115	FD 240	
Interior dimensions						
Width	mm / inch	222 / 8.74	400 / 15.75	600 / 23.62	800 / 31.50	
Height	mm / inch	330 / 12.99	400 / 15.75	480 / 18.90	600 / 23.62	
Depth	mm / inch	277 / 10.91	330 / 12.99	400 / 15.75	500 / 19.69	
Interior volume	l / cu.ft.	20 / 0.7	53 / 1.9	115 / 4.1	240 / 8.6	
Quantity of racks (regular / max.)		2/3	2/5	2/6	2/7	
Load per rack	Kg / lbs	12 / 26	15 / 33	20 / 44	30 / 66	
Permitted total load	Kg / lbs	25 / 55	40 / 88	50 / 110	70 / 155	
Weight (empty)	Kg / lbs	33 / 73	44 / 97	62 / 137	96 / 212	
Temperature data						
Temperature range, 5 °C above ambient up to	°C / °F	300 / 572	300 / 572	300 / 572	300 / 572	
Temperature uniformity (variation 1)	at 70 °C / 158 °F	± K	0.8	0.8	0.7	0.8
	at 150 °C / 302 °F	± K	2.2	2	1.8	2
	at 300 °C / 572 °F	± K	4.3	3.7	3.9	4.3
Temperature fluctuation	± K	0.3	0.3	0.3	0.3	
Heating up time 2)	to 70 °C / 158 °F	Min	7	7	7	11
	to 150 °C / 302 °F	Min	22	24	28	24
	to 250 °C / 482 °F	Min	45	60	49	50
Recovery time after door was open for 30 sec 2)	at 70 °C / 158 °F	Min	2	2	2	2
	at 150 °C / 302 °F	Min	4	5	5	6
	at 300 °C / 572 °F	Min	9	9	12	13
Ventilation data						
Air change	at 70 °C / 158 °F	x/h	59	59	29	19
	at 150 °C / 302 °F	x/h	64	64	32	20
	at 300 °C / 572 °F	x/h	53	53	26	18
Electrical data						
IP system of protection acc. to EN 60529	IP	20	20	20	20	
Nominal voltage (±10%) 50/60 Hz	V	230 1N~	230 1N~	230 1N~	230 1N~	
Nominal power	kW	0.8	1.20	1.60	2.70	
Power plug		shock proof plug				
Unit fuse 5x20mm / 230V / time-lag M	Amp	10 external	10 external	10 external	16 external	
Energy consumption	at 70 °C / 158 °F	Wh/h	145	172	230	370
	at 150 °C / 302 °F	Wh/h	300	429	544	850
	at 300 °C / 572 °F	Wh/h	720	951	1100	1400
Installation category acc. to IEC 61010-1		II	II	II	II	
Pollution degree acc. to IEC 61010-1		2	2	2	2	

Electrical connection data FD-UL acc. to cUL standard (for USA and Canada):

Unit size		FD 23-UL	FD 53-UL	FD 115-UL	FD 240-UL
Electrical data					
Nominal voltage (±10%) 60 Hz	V	115 1N~	115 1N~	115 1N~	208 3N~
Nominal power	kW	0.80	1.20	1.60	2.70
Nominal current	Amp	7.0	10.5	14.0	11.2
Power plug	NEMA	5-15P	5-20P	5-20P	L21-20P
Unit fuse 6,3 x 32 mm / 250V / super time-lag TT	Amp	12,5 external	16 external	16 external	3 x 16 internal

Legend: 1) without outer glass door 2) up to 98 % of the set value

All technical data is specified for units with standard equipment at an ambient temperature of +25 °C / 77 °F and a power supply voltage fluctuation of ±10. The temperature data is determined in accordance to BINDER factory standard following DIN 12880, observing the recommended wall clearances of 10 % of the height, width and depth of the inner chamber. Technical data refer to 100% fan speed.

All indications are average values, typical for units produced in series. We reserve the right to change technical specifications at any time.

	If the cabinet is fully loaded, the specified heating up times may vary according to the load.
---	--

12.7 Equipment and Options Series BD

	To operate the incubator BD, use only original BINDER accessories or accessories / components from third-party suppliers authorized by BINDER. The user is responsible for any risk arising from using unauthorized accessories.
---	--

Unit size	BD 23	BD 53	BD 115	BD 240	BD 400	BD 720
Standard equipment						
Microprocessor temperature controller with LED display, timer function, and ramp function	●	●	●	●	●	●
Temperature safety device class 3.1 acc. to DIN 12880	●	●	●	●	●	●
Inner glass door	●	●	●	●	●	●
Communication interface RS 422	●	●	●	●	●	●
Exhaust duct, internal diameter 50mm / 1.97 inches, with adjustable ventilation slide	●	●	●	●	●	●
Four castors (2 lockable)	--	--	--	--	--	●
Options / accessories						
Rack, chrome-plated or stainless steel	○	○	○	○	○	○
Perforated rack, stainless steel	○	○	○	○	○	○
Access ports with various diameters, with silicone plug	○	○	○	○	○	○
Lockable door	○	○	○	○	○	○
Rubber pads for safe stacking (4 pieces)	○	○	○	--	--	--
Additional Pt 100 temperature sensor, fix or flexible, with external connection including LEMO plug (3 pins)	○	○	○	○	○	○
Water-proof interior socket, IP type of protection 65, 230 V 1N ~ 50-60 Hz. Max. load 500 W	○	○	○	○	○	○
Analog output 4-20 mA for temperature with 6 pole DIN socket, DIN plug included	○	○	○	○	○	○
Disconnectable audible over-temperature alarm	○	○	○	○	○	○
Pen recorder, external	○	○	○	○	○	○
Factory calibration certificate	○	○	○	○	○	○
Extension to factory calibration certificate (additional value)	○	○	○	○	○	○
Temperature measurement with 9 measuring points at a defined temperature with measuring protocol and certificate	○	○	○	○	○	○
Measuring protocol acc. to DIN 12880	○	○	○	○	○	○
Qualification folder	○	○	○	○	○	○
Unit acc. to CUL standard in 115V 1N~60Hz	○	○	○	○	○	○
Rack for 36 Petri dishes, stainless steel	○	○	○	○	○	○
Rack for 6 Petri dishes, stainless steel or colored	○	○	○	○	○	○

Unit size	BD 23	BD 53	BD 115	BD 240	BD 400	BD 720
Options / accessories (continued)						
Tray for rack for 6 Petri dishes, stainless steel	○	○	○	○	○	○
Neutral cleaning agent (liquid concentrate)	○	○	○	○	○	○
Stable table on wheels with castors and locking brakes	--	○	○	○	○	--

Legend: ● Standard equipment ○ Optional -- Not available

12.8 Equipment and Options Series ED

	To operate the heating oven ED, use only original BINDER accessories or accessories / components from third-party suppliers authorized by BINDER. The user is responsible for any risk arising from using unauthorized accessories.
---	---

Unit size	ED 23	ED 53	ED 115	ED 240	ED 400	ED 720
Standard equipment						
Microprocessor temperature controller with LED display, timer function, and ramp function	●	●	●	●	●	●
Temperature safety device class 2 acc. to DIN 12880	●	●	●	●	●	●
Exhaust duct, internal diameter 50mm / 1.97 inches, with adjustable ventilation slide	●	●	●	●	●	●
Four castors (2 lockable)	--	--	--	--	--	●
Options / accessories						
Rack, chrome-plated or stainless steel	○	○	○	○	○	○
Perforated rack, stainless steel	○	○	○	○	○	○
Access ports with various diameters, with silicone plug	○	○	○	○	○	○
Communication interface RS 422	○	○	○	○	○	○
Lockable door	○	○	○	○	○	○
Door with window and interior lightning	○	○	○	○	--	--
FKM door gasket (temperature resistant up to 200 °C)	○	○	○	○	○	○
Rubber pads for safe stacking (4 pieces)	○	○	○	○	--	--
Temperature safety device class 3.1 acc. to DIN 12880	○	○	○	○	○	○
Analog output 4-20 mA for temperature with 6 pole DIN socket, DIN plug included	○	○	○	○	○	○
Disconnectable audible over-temperature alarm	○	○	○	○	○	○
Pen recorder, external	○	○	○	○	○	○
Factory calibration certificate	○	○	○	○	○	○
Extension to factory calibration certificate (additional value)	○	○	○	○	○	○
Qualification folder	○	○	○	○	○	○
Unit acc. to CUL standard in 115 V 1N~60Hz	○	○	○	--	--	--
Unit acc. to CUL standard in 208 V 3N~60Hz	--	--	--	○	○	○
Evaporating dish with rim, small or large	○	○	○	○	○	○
Instrument tray with lid, small or large	○	○	○	○	○	○
Neutral cleaning agent (liquid concentrate)	○	○	○	○	○	○
Stable table on wheels with castors and locking brakes	--	○	○	○	○	--

Legend: ● Standard equipment ○ Optional -- Not available

12.9 Equipment and Options Series FD



To operate the heating oven FD, use only original BINDER accessories or accessories / components from third-party suppliers authorized by BINDER. The user is responsible for any risk arising from using unauthorized accessories.

Unit size	FD 23	FD 53	FD 115	FD 240
Standard equipment				
Microprocessor temperature controller with LED display, timer function, and ramp function	●	●	●	●
Temperature safety device cl. 2 acc. to DIN 12880	●	●	●	●
Exhaust duct, internal diameter 50mm / 1,97 inches, with adjustable ventilation slide	●	●	●	●
Options / accessories				
Rack, chrome-plated or stainless steel	○	○	○	○
Perforated rack, stainless steel	○	○	○	○
Reinforced rack stainless steel, with 1 set rack lockings	--	--	--	○
Access ports with various diameters, with silicone plug	○	○	○	○
Lockable door	○	○	○	○
Door with window and interior lightning	○	○	○	○
FKM door gasket (temperature resistant up to 200 °C)	○	○	○	○
Rubber pads for safe stacking (4 pieces)	○	○	○	--
Temperature safety device class 3.1 acc. to DIN 12880	○	○	○	○
Analog output 4-20 mA for temperature with 6 pole DIN socket, DIN plug included	○	○	○	○
Disconnectable audible over-temperature alarm	○	○	○	○
Pen recorder, external	○	○	○	○
Factory calibration certificate	○	○	○	○
Extension to factory calibration certificate (additional value)	○	○	○	○
Qualification folder	○	○	○	○
Unit acc. to CUL standard in 115 V 1N~60Hz	○	○	○	--
Unit acc. to CUL standard in 208 V 3N~60Hz	--	--	--	○
Evaporating dish with rim, small or large	○	○	○	○
Instrument tray with lid, small or large	○	○	○	○
Neutral cleaning agent (liquid concentrate)	○	○	○	○
Stable table on wheels with castors and locking brakes	--	○	○	○

Legend: ● Standard equipment ○ Optional -- Not available

12.10 Spare parts

	<p>BINDER GmbH is responsible for the safety features of the unit only, provided skilled electricians or qualified personnel authorized by BINDER perform all maintenance and repair, and if components relating to chamber safety are replaced in the event of failure with original spare parts. The user is responsible for any risks arising from using unauthorized accessories/components.</p>
---	--

Accessories and spare parts BD:

Unit size	BD 23	BD 53	BD 115	BD 240	BD 400	BD 720
Description	Art. No.					
Rack, chrome-plated	6004-0050	6004-0002	6004-0003	6004-0004	6004-0005	6004-0006
Rack, stainless steel	6004-0051	6004-0007	6004-0008	6004-0009	6004-0011	6004-0010
Perforated rack, stainless steel	6004-0052	6004-0029	6004-0030	6004-0031	6004-0032	6004-0033
Door gasket silicone	6005-0090	6005-0095	6005-0096	6005-0097	6005-0069	6005-0099
Stable table on wheels with castors and locking brakes	--	9051-0018	9051-0018	9051-0019	9051-0019	--
Unit fuse 5x20mm 250V 10A semi time lag (M)	5006-0012	5006-0012	5006-0012	5006-0012	5006-0012	5006-0012
Rubber pads for safe stacking (4 pc.)	8012-0001	8012-0001	8012-0001	--	--	--
Controller R3				5014-0052		
Thermostat class. 3.1 0 °C / 32 °F to 120 °C / 248 °F				5006-0035		
Turning knob for thermostat class 3.1				8009-0004		
Pilot lamp red				5008-0003		
Temperature sensor Pt 100 straight				5002-0021		
2-channel pen recorder, external				8012-0152		
Calibration certificate				8012-0030		
Extension for calibration certificate (additional value)				8012-0022		
Certificate temperature measurement 9 measuring points				8012-0263		
Spatial temperature measurement (DIN 12880)				8012-0156		
Qualification folder				DL016031		
Neutral cleaning agent, 1 kg				1002-0016		
Rack for 36 Petri dishes, stainless steel				6006-0167		
Rack for 6 Petri dishes, stainless steel				6006-0168		
Rack for 6 Petri dishes, red				6006-0169		
Rack for 6 Petri dishes, green				6006-0170		
Rack for 6 Petri dishes, yellow				6006-0171		
Rack for 6 Petri dishes, blue				6006-0172		
Tray for rack for 6 Petri dishes, stainless steel				6006-0173		

Accessories and spare parts ED:

Unit size	ED 23	ED 53	ED 115	ED 240	ED 400	ED 720
Description	Art. No.					
Rack, chrome-plated	6004-0050	6004-0002	6004-0003	6004-0004	6004-0005	6004-0006
Rack, stainless steel	6004-0051	6004-0007	6004-0008	6004-0009	6004-0011	6004-0010
Perforated rack, stainless steel	6004-0052	6004-0029	6004-0030	6004-0031	6004-0032	6004-0033
Door gasket silicone	6005-0090	6005-0095	6005-0096	6005-0097	6005-0069	6005-0099
Door gasket made of FKM (temp. resistant up to 200 °C / 392 °F)	8012-0493	8012-0494	8012-0495	8012-0496	8012-0497	8012-0498
Stable table on wheels with castors and locking brakes	--	9051-0018	9051-0018	9051-0019	9051-0019	--
Unit fuse 5x20mm 250V 10A semi time lag (M)	5006-0012	5006-0012	5006-0012	--	--	--
Unit fuse 5x20mm 250V 16A semi time lag (M)	--	--	--	5006-0013	--	--
Over-current release category B 16 A	--	--	--	--	5006-0042	5006-0042
Rubber pads for safe stacking (4 pc.)	8012-0001	8012-0001	8012-0001	--	--	--

Controller R3	5014-0052
Thermostat class 2 30 °C / 86 °F up to 320 °C / 608 °F	5006-0031
Turning knob for thermostat class 2	8009-0004
Reset-button for thermostat class 2	6002-0035
Pilot lamp red	5008-0003
Temperature sensor Pt 100 straight	5002-0040
2-channel pen recorder, external	8012-0152
Calibration certificate	8012-0030
Extension for calibration certificate (additional value)	8012-0022
Qualification folder	DL020031
Neutral cleaning agent, 1 kg	1002-0016
Instrument tray with lid, small	4022-0123
Instrument tray with lid, large	4022-0124
Evaporating dish, small	4022-0125
Evaporating dish, large	4022-0126

Accessories and spare parts FD:

Unit size	FD 23	FD 53	FD 115	FD 240
Description	Art. No.			
Rack, chrome-plated	6004-0050	6004-0002	6004-0003	6004-0004
Rack, stainless steel	6004-0051	6004-0007	6004-0008	6004-0009
Perforated rack, stainless steel	6004-0052	6004-0029	6004-0030	6004-0031
Reinforced rack with rack lockings	--	--	--	8012-0345
Door gasket silicone	6005-0090	6005-0095	6005-0096	6005-0097
Door gasket made of FKM (temperature resistant up to 200 °C / 392 °F)	8012-0493	8012-0494	8012-0495	8012-0496
Stable table on wheels with castors and locking brakes	--	9051-0018	9051-0018	9051-0019
Unit fuse 5x20mm 250V 10A semi time lag (M)	5006-0012	5006-0012	5006-0012	--
Unit fuse 5x20mm 250V 16A semi time lag (M)	--	--	--	5006-0013
Rubber pads for safe stacking (4 pieces)	8012-0001	8012-0001	8012-0001	--

Controller R3	5014-0052
Thermostat class 2 30 °C / 86 °F up to 320 °C / 608 °F	5006-0031
Turning knob for thermostat class 2	8009-0004
Reset-button for thermostat class 2	6002-0035
Pilot lamp red	5008-0003
Temperature sensor Pt 100 bend-off	5002-0022
2-channel pen recorder, external	8012-0152
Calibration certificate	8012-0030
Extension for calibration certificate (additional value)	8012-0022
Qualification folder	DL030031
Neutral cleaning agent, 1 kg	1002-0016
Instrument tray with lid, small	4022-0123
Instrument tray with lid, large	4022-0124
Evaporating dish, small	4022-0125
Evaporating dish, large	4022-0126

13. Contamination clearance certificate

Unbedenklichkeitsbescheinigung

Declaration with regard to safety and health

Erklärung zur Sicherheit and gesundheitlichen Unbedenklichkeit

The German Ordinance on Hazardous Substances (GefStofV), and the regulations regarding safety at the workplace, require that this form be filled out for all products that are returned to us, so that the safety and health of our employees can be warranted.

Die Sicherheit und Gesundheit unserer Mitarbeiter, die Gefahrstoffverordnung GefStofV und die Vorschriften zur Sicherheit am Arbeitsplatz machen es erforderlich, dass dieses Formblatt für alle Produkte, die an uns zurückgeschickt wird.



In the absence of a completely filled out form, a repair is not possible.
Ohne Vorliegen des vollständig ausgefüllten Formblattes ist eine Reparatur nicht möglich.

- A completely filled out form should be transmitted by Fax (+49 (0) 7462 2005 93555) or by letter in advance to us, so that this information is available before the equipment/component part arrives. A second copy of this form should accompany the equipment/component part. Eventually the carrier should be informed.

Eine vollständig ausgefüllte Kopie dieses Formblattes soll per Telefax (Nr. +49 (0) 7462 2005 93555) oder Brief vorab an uns gesandt werden, so dass die Information vorliegt, bevor das Gerät/Bauteil eintrifft. Eine weitere Kopie soll dem Gerät/Bauteil beigelegt sein. Ggf. ist auch die Spedition zu informieren.

- Incomplete information or non-conformity with this procedure will inevitably lead to substantial delays in processing. We hope you will have understanding for this measure, which lies outside of our area of influence, and that you will help us to speed up this procedure.

Unvollständige Angaben oder Nichteinhalten dieses Ablaufs führen zwangsläufig zu beträchtlichen Verzögerungen in der Abwicklung. Bitte haben Sie Verständnis für Maßnahmen, die außerhalb unserer Einflussmöglichkeiten liegen und helfen Sie mit, den Ablauf beschleunigen.

- **Please fill out this form completely.**

Bitte unbedingt vollständig ausfüllen!

1.	Unit/ component part / type: / Gerät / Bauteil / Typ:
2.	Serial No./ Serien-Nr.:
3.	Details about utilized substances / biological substances / Einzelheiten über die eingesetzten Substanzen/biologische Materialien:
3.1	Designations / Bezeichnungen:
a)	_____
b)	_____
c)	_____
3.2	Safety measures required for handling these substances / Vorsichtsmaßnahmen beim Umgang mit diesen Stoffen:
a)	_____
b)	_____
c)	_____

3.3	Measures to be taken in case of skin contact or release into the atmosphere / Maßnahmen bei Personenkontakt oder Freisetzung:
a)	_____
b)	_____
c)	_____
d)	_____
3.4	Other important information that must be taken into account / Weitere zu beachtende und wichtige Informationen:
a)	_____
b)	_____
c)	_____
4.	Declaration on the risk of these substances (please checkmark the applicable items) / Erklärung zur Gefährlichkeit der Stoffe (bitte Zutreffendes ankreuzen) :
<input type="checkbox"/>	4.1 For non toxic, non radioactive, biologically harmless materials / für nicht giftige, nicht radioaktive, biologisch ungefährliche Stoffe:
	We herewith guarantee that the above-mentioned unit / component part... / Wir versichern, dass o.g. Gerät/Bauteil...
<input type="checkbox"/>	Has not been exposed to or contains any toxic or otherwise hazardous substances / weder giftige noch sonstige gefährliche Stoffe enthält oder solche anhaften.
<input type="checkbox"/>	That eventually generated reaction products are non-toxic and also do not represent a hazard / auch evtl. entstandene Reaktionsprodukte weder giftig sind noch sonst eine Gefährdung darstellen.
<input type="checkbox"/>	Eventual residues of hazardous substances have been removed / evtl. Rückstände von Gefahrstoffen entfernt wurden.
<input type="checkbox"/>	4.2 For toxic, radioactive, biologically harmful or hazardous substances, or any other hazardous materials / für giftige, radioaktive, biologisch bedenkliche bzw. gefährliche Stoffe oder anderweitig gefährliche Stoffe.
	We herewith guarantee that ... / Wir versichern, dass ...
<input type="checkbox"/>	The hazardous substances, which have come into contact with the above-mentioned equipment/component part, have been completely listed under item 3.1 and that all information in this regard is complete / die gefährlichen Stoffe, die mit dem o.g. Gerät/Bauteil in Kontakt kamen, in 3.1 aufgelistet sind und alle Angaben vollständig sind.
<input type="checkbox"/>	That the unit /component part has not been in contact with radioactivity / das Gerät/Bauteil nicht mit Radioaktivität in Berührung kam
5.	Kind of transport / transporter / Transportweg/Spediteur:
	Transport by (means and name of transport company, etc.) / Versendung durch (Name Spediteur o.ä.)

	Date of dispatch to BINDER GmbH / Tag der Absendung an BINDER GmbH:

We herewith declare that the following measures have been taken / Wir erklären, dass folgende Maßnahmen getroffen wurden:

- Hazardous substances were removed from the unit / component part, so that no hazard exists for corresponding persons in the handling or repair of these items / das Gerät/Bauteil wurde von Gefahrstoffen befreit, so dass bei Handhabung/Reparaturen für die betreffenden Person keinerlei Gefährdung besteht
- The unit was securely packaged and properly identified / das Gerät wurde sicher verpackt und vollständig gekennzeichnet.
- Information about the hazardousness of the shipment (if required) has been provided to the transporter / der Spediteur wurde (falls vorgeschrieben) über die Gefährlichkeit der Sendung informiert.

We herewith commit ourselves and guarantee that we will indemnify BINDER GmbH for all damages that are a consequence of incomplete or incorrect information provided by us, and that we will exempt BINDER GmbH from eventual damage claims by third parties./ Wir versichern, dass wir gegenüber BINDER für jeden Schaden, der durch unvollständige und unrichtige Angaben entsteht, haften und BINDER gegen eventuell entstehende Schadenansprüche Dritter freistellen.

We are aware that, in accordance with Article 823 of the German Civil Code (BGB), we are directly liable with regard to third parties, in this instance especially the employees of BINDER GmbH, who have been entrusted with the handling / repair of the unit / component. / Es ist uns bekannt, dass wir gegenüber Dritten – hier insbesondere mit der Handhabung/Reparatur des Geräts/des Bauteils betraute Mitarbeiter der Firma BINDER - gemäß §823 BGB direkt haften

Name: _____

Position: _____

Date / Datum: _____

Signature / Unterschrift: _____

Company stamp / Firmenstempel:



Equipment that is returned to the factory for repair must be accompanied by a completely filled out contamination clearance certificate. For service and maintenance works on site, such a contamination clearance certificate must be submitted to the service technician before the start of the works. No repair or maintenance of the equipment is possible, without a properly filled out contamination clearance certificate.

